

Creating innovative locker solutions for every business

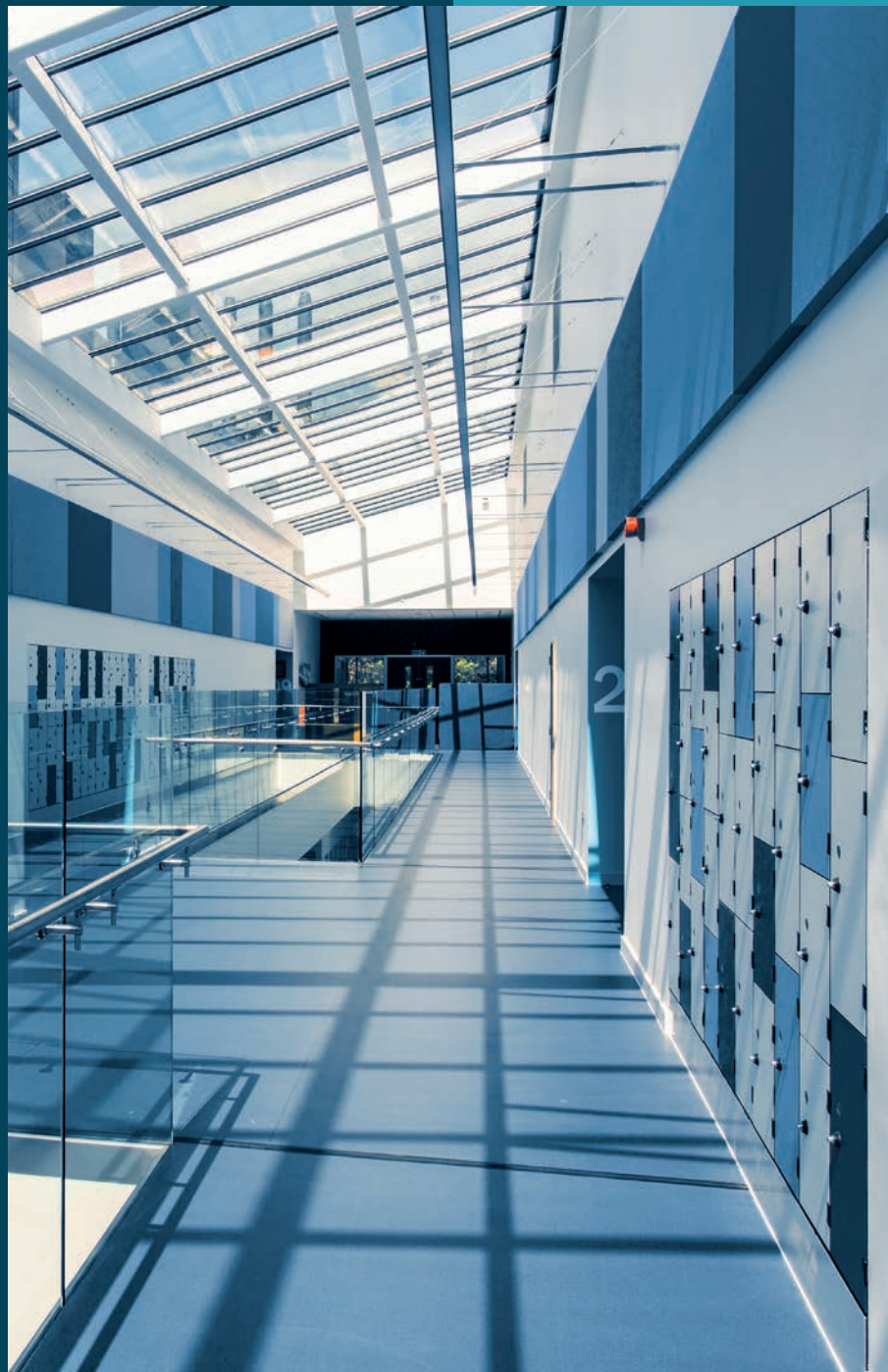

Probe

Delivering quality products & solutions

Over 60 years in the making

Providing industry-leading storage products through a nationwide network of distributors, you benefit from our decades of experience and know-how to best serve your customers.

Unrivalled in the locker market, our design-led features, modern aesthetics, and unparalleled support materials enable us to meet the secure storage requirements of any sector.

Manufacturing excellence

With an extensive range of locker types available in various sizes, configurations, materials and colours, you can fulfil the requirements of any working environment.

Operating in accordance with the latest ISO standards and NEBOSH regulations, quality is assured across all our UK manufacturing locations.

As a Made in Britain member, you and your customers are guaranteed that all Probe products are manufactured here in the UK and meet the highest British standards.

Being a trusted Whittan brand, we are dedicated to enhancing our environmental, social and ethical impact. Our Gold EcoVadis rating recognises our commitment to fostering sustainable business practices and reducing Greenhouse Gas (GHG) emissions.



When you choose Probe, you benefit from shorter lead times, less supply chain risks and better customer service.

Proven standards

Unrivalled in the locker market to provide unmatched quality and satisfaction, Probe products are manufactured to the highest quality standards to meet the secure storage requirements of your customers.

PROBE**FIREZERO**

Independently tested for Fire combustibility and adhering to European Standard: EN 13501-1: 2007 +A1: 2009, Probe lockers are built to endure the extreme temperatures experienced in the outbreak of a fire and will not:

- Combust
- Increase
- Sustain any fire within its proximity

MEETS BS 4680: 1996

excluding size specification

Probe lockers have been independently tested and conform to BS 4680:1996, meeting British standards for quality and safety, to provide your customers with secure and reliable storage solutions.

Warranty

Committed to enhancing the quality and durability of our products, our lockers come with a 7-year warranty on the carcass and a 5-year warranty on electrical components for peace of mind for you and your customers.



ACTIVECOAT anti-bacterial technology

Reduce cross-contamination

Included as standard in the powder coating process, ActiveCoat prevents the growth and migration of potentially harmful bacteria, mould, fungi, algae and more, reducing the risk of cross-contamination from surface to surface.

- ✓ 99.9% reduction in E-coli & MRSA super bug
- ✓ Independently tested
- ✓ 100% safe to humans
- ✓ Effective for the life of the coating

All plastic components used in the manufacture of Probe products incorporate a silver-based anti-bacterial agent.

Independently tested and verified

ActiveCoat has been independently tested and verified to conform to ISO 2219. Offering strong antibacterial properties against the most widely encountered and problematic organisms, ActiveCoat effectively reduces bacteria populations by 99.9%.

Long term protection

Unlike anti-bacterial sprays and chemical disinfectants which rely on repeated application, ActiveCoat contains anti-bacterial agents distributed throughout the powder coating, continuing to offer antimicrobial properties for the life of the coating.

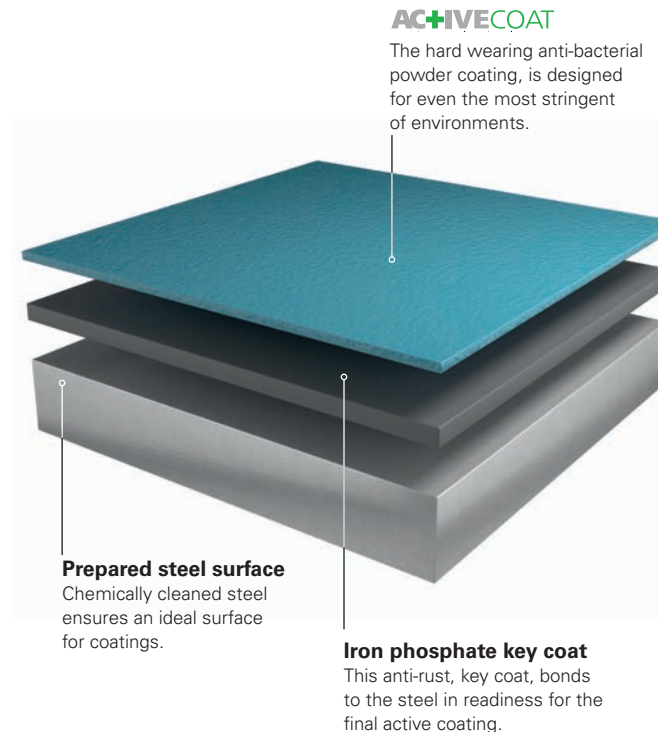

The science behind the solution

Operating on a molecular level, ActiveCoat is highly effective at very low concentrations. The silver-based additives fight microbes on three fronts:

- They bind with the cell wall and impede growth.
- They inhibit enzyme production, hampering the cell's ability to produce energy.
- They disrupt cells' DNA, preventing cellular replication.

This three-pronged attack stops microbes in their tracks and drastically reduces microbial load on treated surfaces.

Solutions for every sector

From office to industrial, education to leisure, medical to manufacturing, indoor or outdoor, wet or dry, front of house or back of house, we have an innovative solution for any environment.



Retail



Education



Utilities



Pharmaceutical



E-commerce

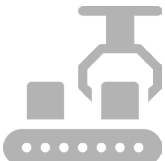

Manufacturing



Golf



Food & Drink



Healthcare



Industrial



Swimming Pools



Hospitality



Outdoors



Gyms



Emergency Services



Office

Locker features & benefits



Our steel lockers are a great way to provide durable personal storage in schools, factories and offices and dry areas in sport centres and gyms. Our metal lockers are designed to withstand regular use and resist daily wear and tear making them ideal for use in busy environments.

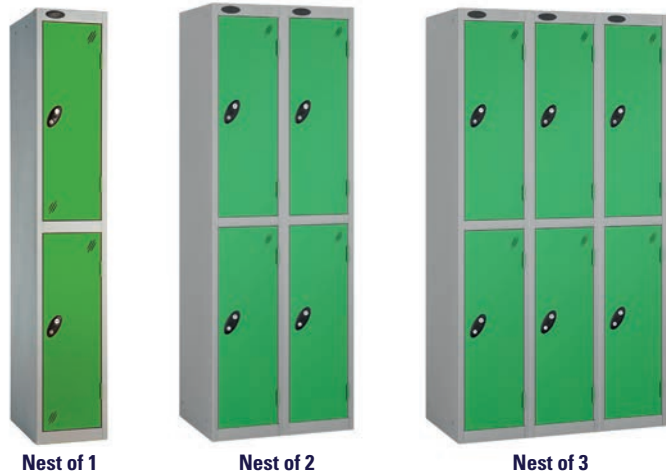

Lockers can be supplied as nested units with lockers of the same overall dimensions, sharing common side panels, manufactured and supplied fitted together. Locker nesting makes efficiencies in manufacture, delivery, installation and space utilisation.

Additional door perforations- standard at additional cost

Air vent system on each door.*

5 knuckle hinges.

Welded internal door strengthener *
Not available on some products due to small door size.

Full door perforations
Available as an option.
Minimum order quantity.

10 Micro sprung disc lock

Through frame locking
For added security, the cam locates through aperture in frame preventing door being easily forced open.

Lockers are manufactured from high grade cold reduced sheet to BS 1449 SECTION 1.3: 1991.

Front frame & doors- 0.9mm

Sides, shelves, back, base & top- 0.7mm

Welded compartment divider for high security.

Nominal clear entry widths
Clear entry width = locker width minus 64mm

* Door strengthener not needed on some products. Air vent system not available on some products due to small door size.
Excludes **EXPRESSBOX** and **SUPEREXPRESSBOX** lockers.

Steel locker colours

Standard door colours



Red
Similar to BS 04 E53

Blue
Similar to RAL 5019

Yellow
Similar to RAL 1004

Green
RAL6018

White
RAL 9016

Black
RAL 9004

Silver
RAL 9006

Autumn door colours



Orange
RAL 2003

Jade
RAL 6021

Ocean
RAL 5024

Lemon
RAL 1016

Lilac
RAL 4008

Body colours



Silver
RAL 9006

White
RAL 9016

Black
RAL 9004

These colours are available, from stock, for 305mm wide lockers, other sizes may increase lead times.

EXPRESSBOX door colours - Silver body only



Blue
Similar to RAL 5019
5 day delivery

Red
Similar to BS 04 E53

Yellow
Similar to RAL 1004

Green
RAL6018

White
RAL 9016

Black
RAL 9004

Silver
RAL 9006

10 day delivery

ACTIVECOAT All Probe products come as standard with ActiveCoat anti-bacterial powder coating.

Please note that due to printing restrictions colours represented may differ from original product. We recommend you request a colour swatch before ordering.

Standard steel lockers

Stylish and secure range of full height personal storage solutions for any workplace.

- Probe steel lockers are manufactured in the UK to the highest ISO standards.
- ActiveCoat, the high tech anti-bacterial coating is standard on all lockers.
- Available in a wide range of vibrant door colour and contrasting body colours.
- Available in nests of 1, 2 or 3.



Single compartment

Fixed top shelf with double coat hook.

- W 305 x D 305 mm
- W 305 x D 380 mm
- W 305 x D 460 mm
- W 380 x D 380 mm
- W 380 x D 460 mm
- W 460 x D 460 mm

Two compartment

Double coat hook per compartment.

- W 305 x D 305 mm
- W 305 x D 380 mm
- W 305 x D 460 mm
- W 380 x D 380 mm
- W 380 x D 460 mm
- W 460 x D 460 mm

Three compartment

- W 305 x D 305 mm
- W 305 x D 380 mm
- W 305 x D 460 mm
- W 460 x D 460 mm

Four compartment

- W 305 x D 305 mm
- W 305 x D 380 mm
- W 305 x D 460 mm
- W 380 x D 380 mm
- W 380 x D 460 mm
- W 460 x D 460 mm



See **page 7** for colour options.



See **pages 44** for locking options.

ACTIVECOAT

ActiveCoat technology as standard.



Five compartment
W 305 x D 305 mm
W 305 x D 380 mm
W 305 x D 460 mm

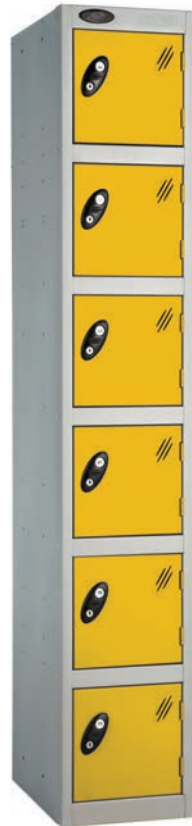

Six compartment
W 305 x D 305 mm
W 305 x D 380 mm
W 305 x D 460 mm
W 380 x D 380 mm
W 380 x D 460 mm



Eight compartment
W 305 x D 460 mm



Ten compartment
W 380 x D 460 mm



Fifteen compartment
W 380 x D 460 mm



Sixteen compartment
W 305 x D 460 mm



Workwear lockers

Keeping clean garments and soiled work overalls separate can often be a problem.

- Clean & Dirty locker solves this by providing a centre partition with a double coat hook to either side.
- Identical in overall size, the Uniforms Locker has three handy shelves to one side of the partition.
- Space saving Two person and Twin lockers can accommodate two people in the same amount of space as single door locker.

Clean & Dirty locker



Complete with full width internal top shelf 305mm high, vertical centre partition and two double coat hooks.

W 460 x D 460 mm

Top compartment height – **305mm**

Uniform / Janitors locker



Complete with full width internal top shelf 305mm high, vertical centre partition, double coat hook and a further three half width shelves.

W 460 x D 460 mm

Top compartment height – **305mm**



See **page 7** for colour options.



See **pages 44** for locking options.

AC+IVECOAT

ActiveCoat technology as standard.

Two person locker

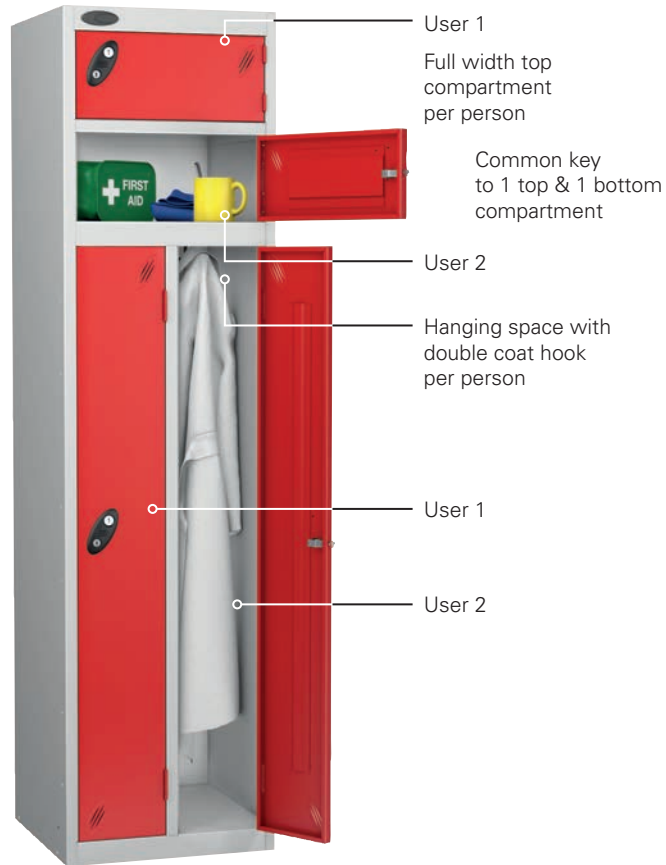

Provides two sections per user with a common key to fit both.
One, 180mm high, full width compartment at the top of the locker and a vertical compartment fitted with a double coat hook.

W 460 x D 460 mm

Top door height - **180mm**

Twin locker



Each compartment comes with 305mm high internal top shelf and a double coat hook.

W 460 x D 460 mm

Top compartment height - **305mm**



Sloping tops are available on our garment lockers. They are essential in hygiene sensitive locations (such as hospitals and the food industry). The slope prevents items and litter being left on locker tops and makes cleaning easier. Sloping tops increase the overall height of the locker.



Two hardwood slats and metal framework form a bench seat in front of the locker, allowing full access to the locker. Units are 400mm high and are complete with adjustable feet.



Lockers are often used in areas where floors need frequent cleaning. Locker stands are 150mm high providing easy floor access.



Large capacity lockers

These larger lockers are ideal for storing bulky items of protective clothing or uniforms safe and secure.

Hi-capacity locker



Extra wide locker for storing bulky clothing and work wear. Doors feature 2 door locking. No other lock options available

W 610 x D 460 mm

Police locker



The Probe Police Locker is designed specifically to accommodate personal body armour and each compartment includes a top shelf and double coat hook.

W 460 x D 550 mm



AC+IVECOAT
ActiveCoat technology as standard.

Garment dispensers/collector

Garment dispensers



Single service door

The full-height main door allows access to all of the individual compartments, for re-stocking with laundered clothing.



Individual access

Lockers provide each worker with access to their secure compartment; to collect a freshly laundered issue of clothing.

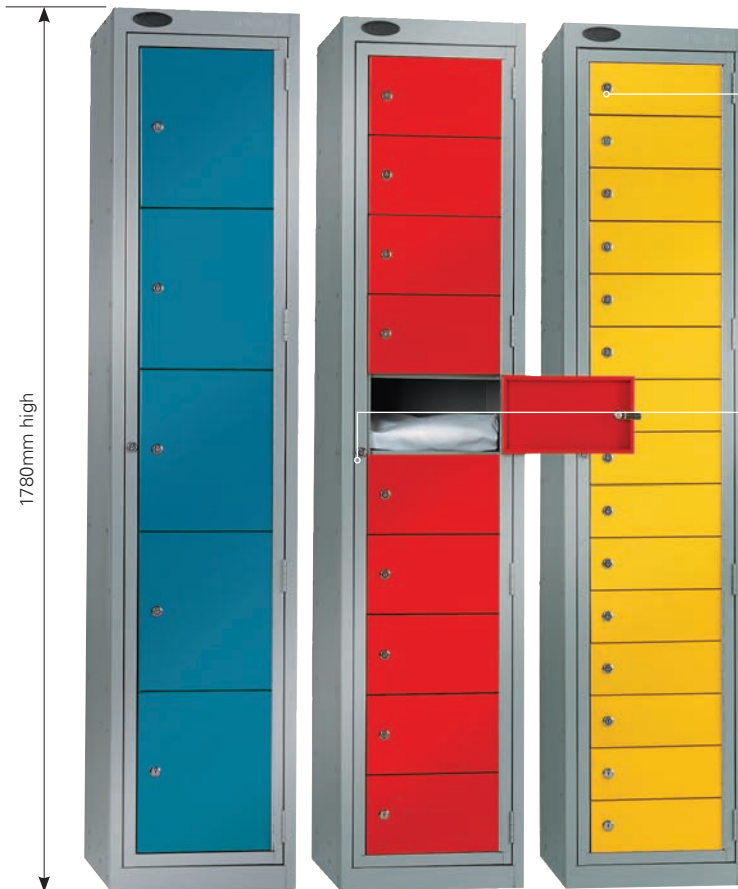

Key access to individual compartment

Full-height main door allows access to all of the individual compartments

1780mm high

W 380 x D 460 mm



A single service door provides access to all the inner compartments of these Garment Dispensers enabling the distribution of clean garments, towels etc. Individual compartments remain secure and require keyed access.

Garment collector



Anti-theft shelf, angled inside 'post slot'

Hooks for laundry collection sack (sack not included)

Workers 'post' their used garments into an adjacent Collection Locker. This separation of clean and used items can help in maintaining a hygienic working environment.

W 380 x D 460mm

MINIBOX steel lockers

When space is at a premium these multi compartment lockers offer greatly increased compartments for the locker footprint.

- They can be the perfect solution to storing personal effects, electronic devices like phones just about anything small you need to lock away.

Minibox 8 door slim



Ideal for small storing phones, keys and wallets.



This locker has **eight** individual compartments and can be wall mounted or stacked to create a wall of handy sized compartments ideal for phones and small items.

H 410 x W 900 x D 230 mm

Compartment clear entry
W 155 x H 155 mm

Minibox 20 door deep



Units can be stacked on top of each other using side fixing straps.

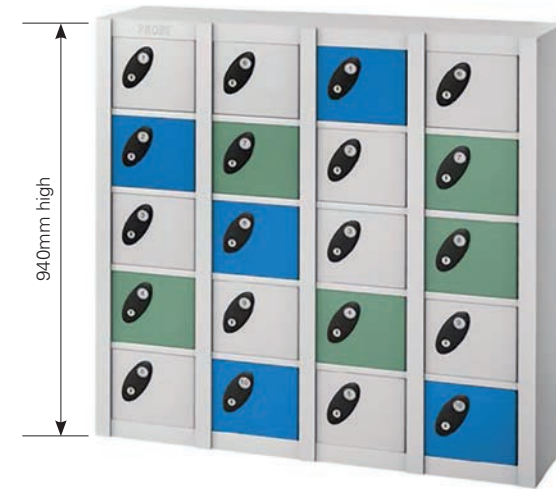

Offering **twenty** deeper individual compartments this locker and can be stacked to create a wall of compartments.

H 940 x W 900 x D 380 mm

Compartment clear entry
W 155 x H 155 mm

Lock types L and H are not compatible with this locker.



See **page 7** for colour options.



See **pages 44** for locking options.

AC+IVECOAT

ActiveCoat technology as standard.

Small compartment lockers

16 compartment locker



This full height small compartment locker from Probe offers efficient use of space when storing small items like keys, phones and wallets.

W 305 x D 460 mm

Compartment clear entry height – **H 50 mm**

Personal effects locker



This slim wallet locker offers convenient safe storage of small items like keys, wallets and cameras.

W 250 x D 180 mm

Compartment size
H 90 x W 192 x D 180 mm

Quarto locker

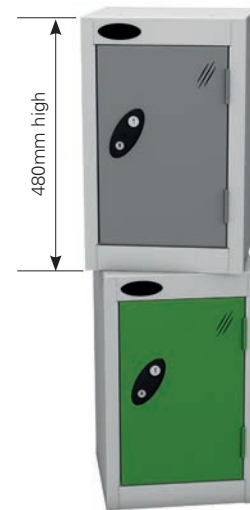

Quartos have been designed for use individually, bolted together in blocks or to complement other locker combinations by acting as linking bridges or extra top lockers.

W 305 x D 305 or 460 mm

Compartment size
H 380 x W 241 mm



Cube locker



Use these handy lockers as multi-purpose storage units. Offered in three sizes they are supplied pre-drilled for bolting together in blocks as needed. Each Cube has the same side length.

305, 380 or 460 mm

Clear entry
250, 300 or 330 mm

Autumn colours

These great colours have been introduced to give you even more choice.

- There are five fresh door colours to choose from and the choice of black, white or silver body colours.
- These lockers have all the same quality features as the existing Probe range so you can be sure of a long lasting storage solution.



See **page 7** for colour options.

ACTIVECOAT

ActiveCoat technology as standard.



Black body



Silver body



White body

Golf lockers

These lockers have been specifically designed for use in golf and sports clubs for the storage of golf clubs.

- Available with inset painted or plant on wood effect laminate doors.



Painted Inset steel doors

Provide a visual contrast between the door colour and the locker frame.



MFC plant-on doors

Cover the front face of the locker body, creating a wall of colour.



See pages 7 & 36 for colour and finish options.



See pages 44 for options.

AC+IVECOAT

ActiveCoat technology as standard.



Top locker

Full height door locker and is designed to sit on top of the golf bottom Locker

Three quarter depth bottom shelf allows golf bag to sit above footwear.

W 380 x D 460 mm

W 460 x D 460 mm



Beech golf seat

Slatted bench seat fits in front without obstructing access to the locker.

H 405 mm



Part height door bottom locker

Designed with a shortened door to accommodate a golf bench without obstructing access of your golf clubs into the bottom locker.

Three quarter depth top shelf for storage of footwear.

W 380 x D 460 mm

W 460 x D 460 mm

EXPRESSBOX steel lockers



Limited range of popular 1800mm high lockers available with blue door and silver body on a 5 day delivery. These single lockers come fitted with cam locks in 5 door configurations and 3 sizes.

FREE fast delivery!*

*Free delivery for UK mainland only.

5 day delivery!**

**FREE delivery of up to 10 per size, blue door / silver body lockers with cam locks, in 5 days.

No minimum order!

In stock ready to go...

All other sizes, nests, locks and colours available on a 10 day lead time.



See **page 7** for colour options.

AC+IVECOAT

ActiveCoat technology as standard.



Type A cam lock

Micro sprung 10 disc lock featuring 3000 serial combinations exclusive to Probe. Two keys included.

Probe EXPRESSBOX colours

ActiveCoat technology as standard.

Blue doors = Similar to RAL 5019

Silver body - RAL 9006

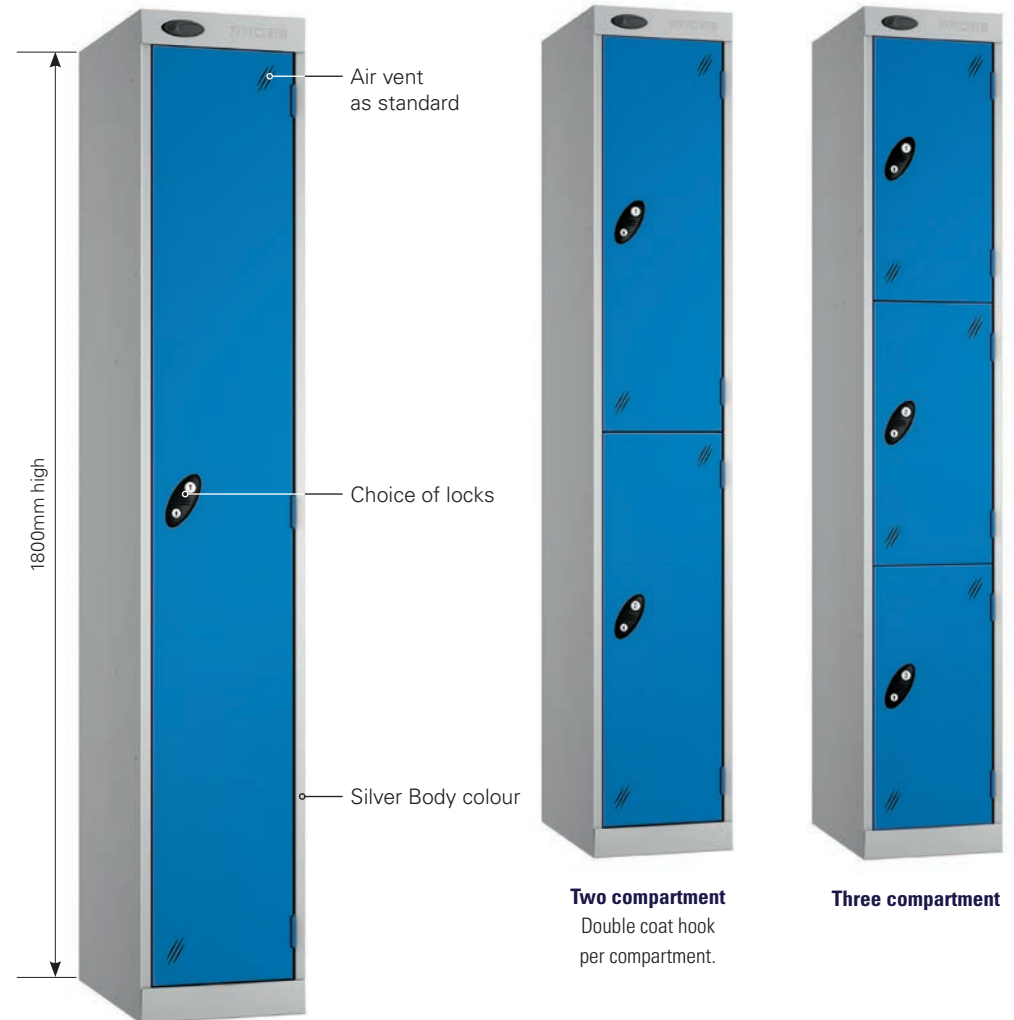

Single compartment

Fixed top shelf with double coat hook.

Two compartment

Double coat hook per compartment.

Three compartment

W 300 x D 300 mm
W 300 x D 450 mm
W 450 x D 450 mm

SUPEREXPRESSBOX steel lockers

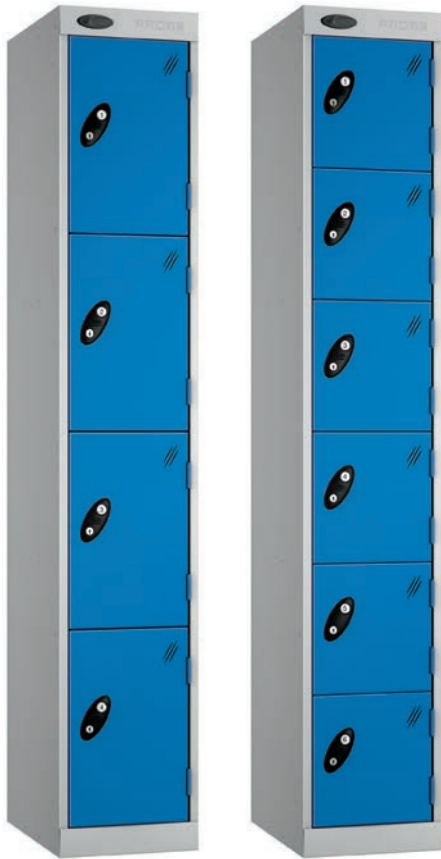

Four compartment

Six compartment

Need lockers in a hurry. We have a limited range of blue door lockers available on a 48 hour delivery. These single lockers come fitted with cam locks in 3 door configurations and 2 sizes.

FREE fast delivery!*

*Free delivery for UK mainland only.

48hr delivery!**

**FREE delivery of up to ten, blue door / silver body lockers, in 48 hours.

Cam lock only.

In stock ready to go...

Probe SUPEREXPRESSBOX colours

ActiveCoat technology as standard.

Blue doors = Similar to RAL 5019

Silver body - RAL 9006

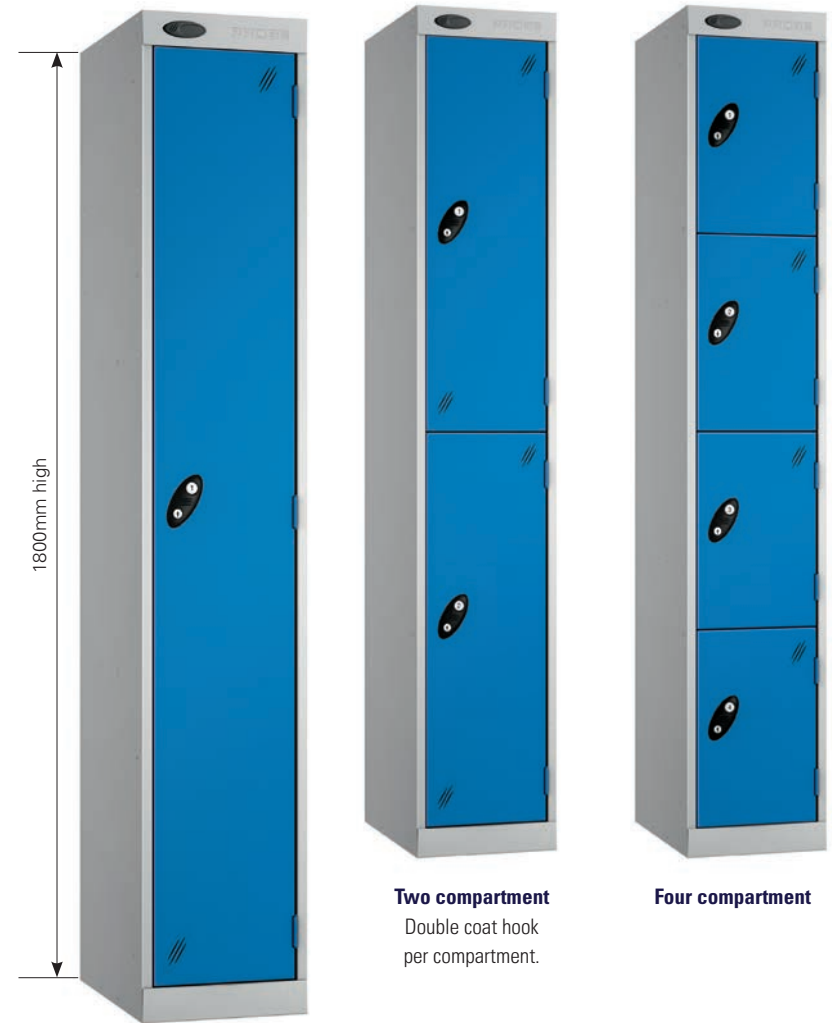

1800mm high

Single compartment

Fixed top shelf with double coat hook.

Two compartment

Double coat hook per compartment.

Four compartment

W 300 x D 300 mm

W 300 x D 450 mm



Security lockers - providing a visual deterrent to theft

Probe Clear View and Vision lockers allow employees to store personal belongings securely while providing a visual deterrent, offering a clear view of the interior of each compartment.

With the addition of clear polycarbonate vision panels in each compartment, Vision lockers provide visibility of the contents of each locker.

- Allows compartment inspection from outside the door.
- Deters concealment within the locker.
- Available in nests of 1, 2 or 3.
- Ideal for retail, stockroom and warehouse environments.

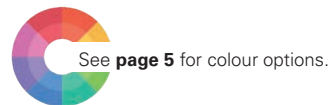

AC+IVECOAT
ActiveCoat technology as standard.

Vision Lockers



Clear View lockers, complete with 4 mm shatter-proof clear polycarbonate doors, allow an unrestricted view of the locker and the entirety of its contents without unlocking the locker door.

- The ideal deterrent for businesses at risk of losing high-value stock.
- Coin-operated locks not available on 5 or 6 compartment lockers.
- A welded plinth between each compartment for added strength.
- Available in nests of 1, 2 or 3.
- Ideal for retail, stockroom and warehouse environments.



Clear View Lockers



Education lockers

With many years of experience supplying innovative storage solutions for schools, colleges and universities, our range of steel lockers can be used across all age groups.

Education lockers have been specifically designed with users in mind, ensuring lockers and compartments are within the height range of the user age group for easy access and reach.

- Quarto, cube and low lockers are ideal for **key stage 1**.
- For **key stage 2** three quarter height lockers ensure pupils do not stretch or overreach to use them.
- For **key stage 3** and higher education full height steel, laminate and aluminium lockers fit the bill.
- A wide range of charging lockers are also available, offering safe and secure charging for computers, laptops and other electronic devices around educational facilities. (See Page 26 for more info)

Standard lockers

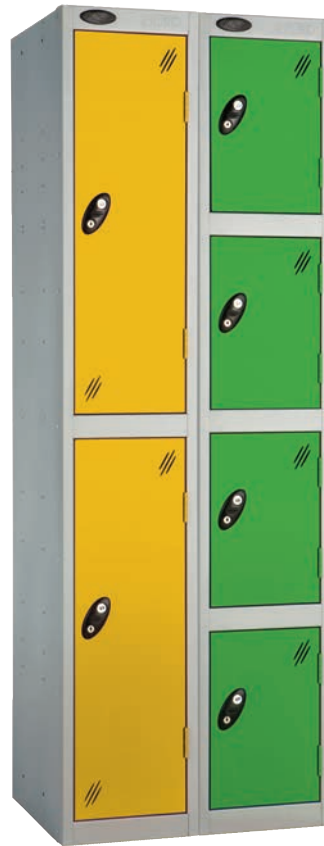

Stylish and secure storage solutions, lift the atmosphere with these bright and contemporary colours.

[See pages 8-9](#)

Charging lockers



Probe offer a comprehensive range of charging and storage lockers for a variety of smart devices. There's a smart device solution to suit your needs.

[See pages 24-29](#)

Quarto & Cubes lockers



Use these handy lockers as multi-purpose storage units. They are supplied pre-drilled for bolting together in blocks or to complement other locker combinations by acting as linking bridges or extra top lockers.

[See page 15](#)

ACTIVECOAT

ActiveCoat technology as standard.

Probe Lockers

Low lockers



Low lockers are ideal for nursery, infant and junior schools. The single compartment low locker, includes a top shelf and double coat hook.

W 305 x D 305 mm
W 305 x D 460 mm

Three quarter locker



The three quarter locker fills the gap between standard low lockers and full height lockers.

W 305 x D 305 mm
W 305 x D 460 mm

Laminate door lockers

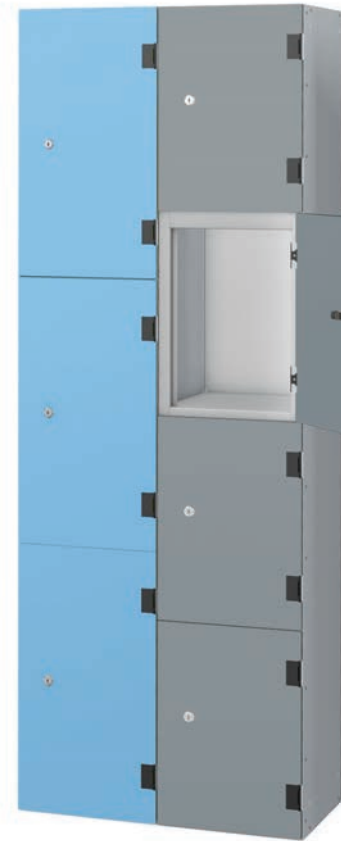

High quality steel lockers with 10mm solid grade laminate with overlay or inset doors.

[See pages 39-39](#)

Aluminium lockers



Zenbox and Zenbox Ultra aluminium lockers with solid grade laminate doors are the perfect choice for demanding, wet or humid environments such as swimming pools.

[See pages 40-43](#)

POWERBOX charging lockers

The innovative **POWERBOX** locker range has been designed to provide secure charging facilities for a variety of valuable electrical goods. Available in a range of sizes and door configurations, our charging lockers are adapted for laptops, tools and small items.

UK CA The only charging locker in the UK market tested to **BS EN ISO/IEC 17050-1:2010**.



* 5 years for electrical parts.

All Powerbox lockers should be securely fixed off the wall, with battens, by 25mm for air movement and to avoid lockers tipping.



See **page 7** for colour options.



See **pages 44** for locking options.

AC+IVECOAT

ActiveCoat technology as standard.



A wide variety of locking solutions are available.

Welded internal door strengthener on larger doors.

Doors secured by a sturdy hinge.



The Probe power spine is at the heart of our Powerbox range of charging lockers, choose from **USB-C & USB-A** or **UK three pin plug**.

Lockers are supplied with an IEC-C inlet which is powered by a 2 metre 'kettle lead' with a 10 amp fused RCD cable.



TOOLBOX



Tool charging locker

Power tools, batteries and chargers are vulnerable to theft when left to charge on-site.

For safe, secure battery charging, **TOOLBOX** lockers allow you to charge your equipment unattended, confident in the knowledge it is safe from thieves.



The Probe power spine is at the heart of our Powerbox range of charging lockers, choose from **USB-C & USB-A** or **UK three pin plug**..



Perforated doors for added ventilation and limited visibility available at extra cost.

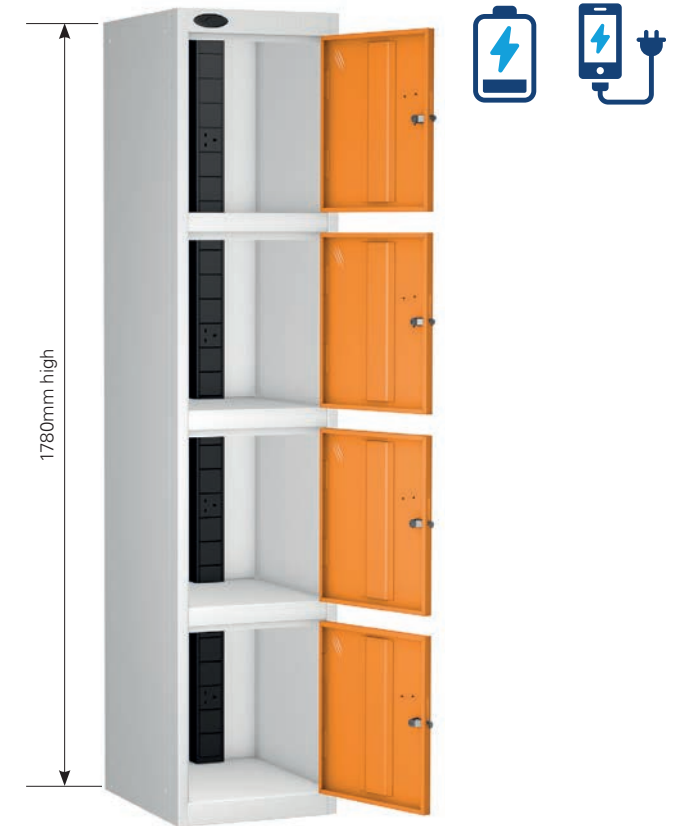

Our Toolbox locker is ideal for large managed buildings that may have several maintenance personnel on-site or even construction sites allowing contractors to store and charge their equipment safely and securely. With a coin operated lock specified, these units can even generate revenue.

W 380 x D 460 mm

LAPBOX

Ideal for schools, colleges and universities that are reliant on laptops and portable devices, our range of laptop charging lockers are designed to keep devices safely charged and ready to use.

UK CA The only charging lockers in the UK market tested to **BS EN ISO/IEC 17050-1:2010**.



The Probe power spine is at the heart of our Powerbox range of charging lockers, choose from **USB-C & USB-A** or **UK three pin plug**.



* 5 years for electrical parts.



See **page 7** for colour options.



See **pages 44** for locking options.

AC+IVECOAT

ActiveCoat technology as standard.

Laptop charging trolley



Individual door gives access to users compartment only.



1100mm high

Individual door gives access to users compartment only.

USB-C & USB-A or UK three pin plug.

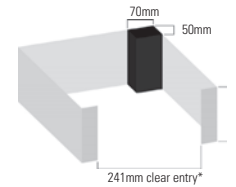

Sixteen compartment charging locker available with **two** or **sixteen** door access. Fully charged computers can be moved between classrooms, offices, conference rooms or hospital departments. Trolley has four swivel lockable wheels for easy moveability.

W 900 x D 540 mm

Also available as non-charging laptop storage locker.

Laptop charging lockers



Eight door locker allows individual access too compartment.

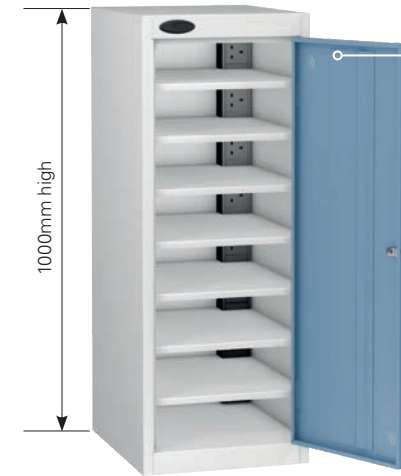

1000mm high

Single door locker is ideal for where lockers are held and distributed centrally.

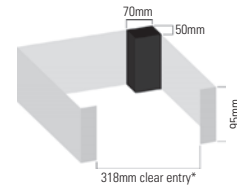

Eight compartment charging locker available with **single** or **eight** door access.

W 380 x D 460 mm

Also available as non-charging laptop storage locker.

*Please consider the charging plug when ascertaining if your device will fit in the locker compartment. Electronic devices and charging cables not included.



Ten compartment charging locker available with **single** or **ten** door access.

W 330 x D 460 mm

Non-charging **ten compartment** or **fifteen compartment** lockers are also available with either **single** or **individual** doors.

All Powerbox lockers should be securely fixed off the wall, with battens, by 25mm for air movement and to avoid lockers tipping.



TABBOX

With electronic tablets and devices used in a wide range of working environments, **TABBOX** provides a safe and secure charging station, with options available to offer either static or mobile charging.



The Probe power spine is at the heart of our Powerbox range of charging lockers, choose from **USB-C & USB-A** or **UK three pin plug**.



* 5 years for electrical parts.

All Powerbox lockers should be securely fixed off the wall, with battens, by 25mm for air movement and to avoid lockers tipping.



See **page 7** for colour options.



See **pages 44** for locking options.

AC+IVECOAT

ActiveCoat technology as standard.

Tablet charging lockers

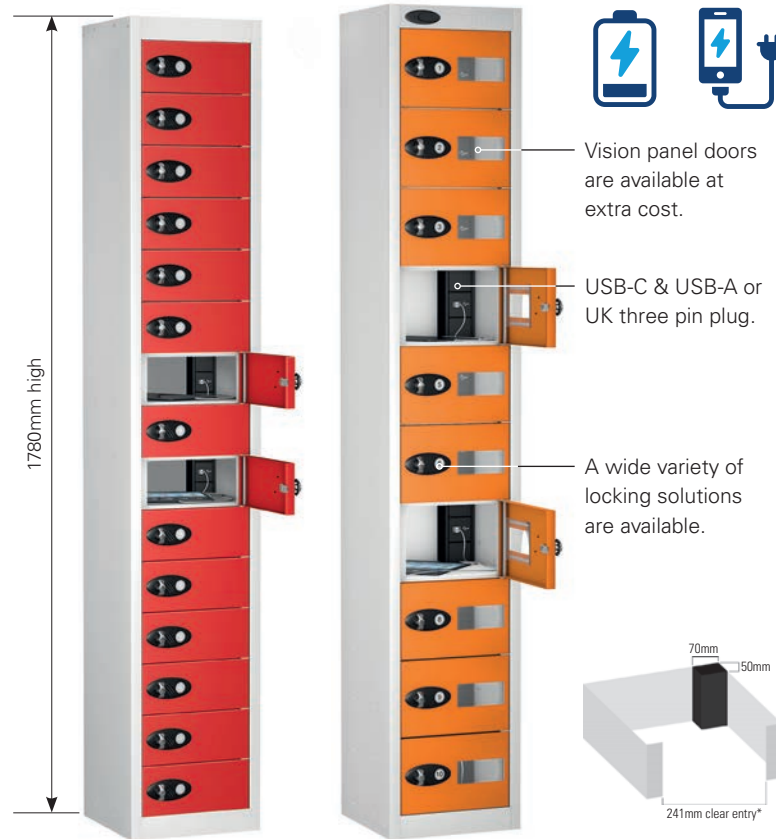

Ten or **fifteen compartment** charging locker available with **single** or **individual** door access. 15 compartment individual door is only available with dual charging USB-A / 3 pin plug.

W 305 x D 305 mm

Ten or **fifteen compartment** non-charging tablet locker with either **single** or **individual** door access is also available for the safe storage of equipment.

W 305 x D 305 mm

*Please consider the charging plug when ascertaining if your device will fit in the locker compartment. Electronic devices and charging cables not included.

UK CA The only charging lockers in the UK market tested to **BS EN ISO/IEC 17050-1:2010**.

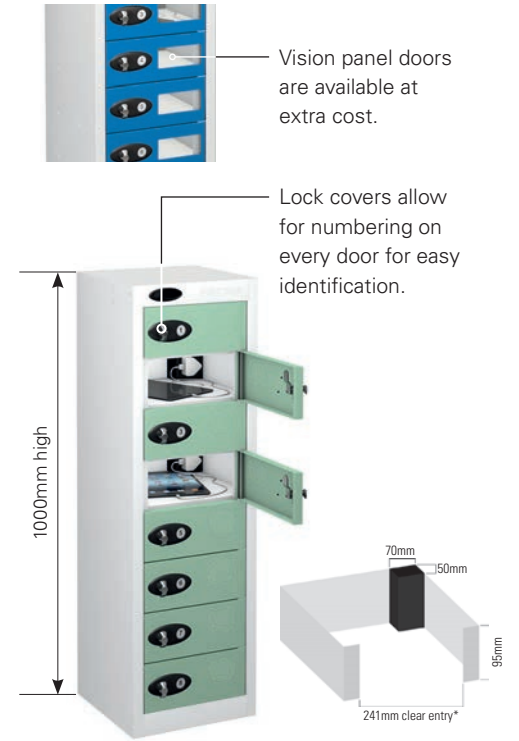

Low **eight compartment** charging locker available with **single** or **eight** door access.

W 305 x D 305 mm

Both versions are available as non-charging tablet lockers.

Tablet charging trolley



Vision panel doors are available at extra cost.

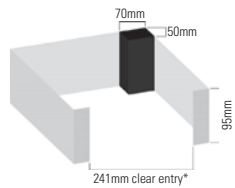

Sixteen compartment charging locker available with **two** or **sixteen** door access. Trolley has four swivel lockable wheels for easy moveability.

W 740 x D 390 mm

Both versions are available as non-charging tablet lockers.



PODBOX- Space saving locker pods



Reducing floor space used by 70%, POD lockers are designed to maximise compartment numbers in locker rooms.

- Choose from 7 or 11 space-saving pods with the option of rotating bases and sloping top canopies.
- Locker pods are individually segmented and connected to form a pod of 7 or 11 lockers
- Supplied with cam locks as standard with other locking options available
- Locker Pods are 1780mm in height and 460mm in depth.



Even the standard locks feature a massive 3000 serial combinations.



The Hasp & Staple allows padlock fitting. Shank diameter: min 5mm, max 7mm (Padlock sold separately).

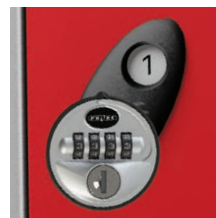

A simple and effective 4 digit combination lock.



Optional sloping canopy

Prevents accumulation of rubbish. 200mm high.

Additional ventilation

For those applications where increased ventilation or visibility is desired.



360° rotating base option

This unique option allows the Locker Pod to be easily rotated through 360° allowing Pods to be positioned closer together giving even more space.

Incorporating inertia braking system. Add 100mm to height of Locker Pod.



See **page 7** for colour options.



See **pages 44** for locking options.

AC+IVECOAT

ActiveCoat technology as standard.



Strong robust construction providing many years of service.



Available in 6 exciting door colours with a stylish silver body to brighten up your staff rooms.



These unique Locker Pods are designed to maximise compartment numbers in your locker room.



Four locking styles available to suit your individual needs.

7 seed pods

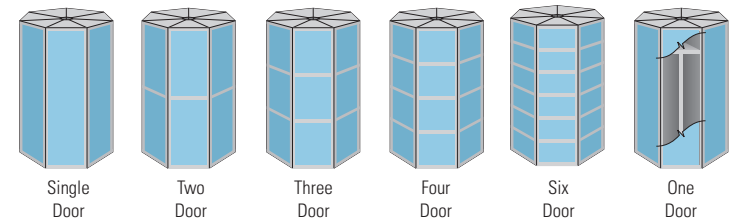

Seed	Doors	Compartments	Type
7	1	7	Standard locker
7	2	14	Standard locker
7	3	21	Standard locker
7	4	28	Standard locker
7	6	42	Standard locker
7	1	7	Clean & Dirty locker

11 seed pods

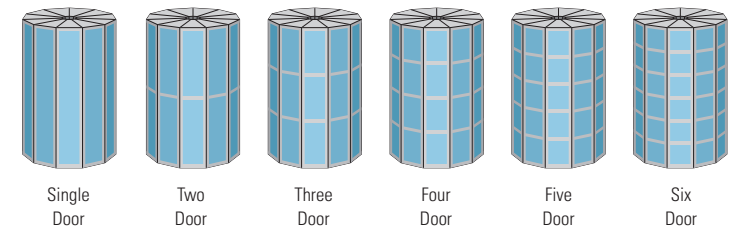

Seed	Doors	Compartments	Type
11	1	11	Standard locker
11	2	22	Standard locker
11	3	33	Standard locker
11	4	44	Standard locker
11	5	55	Standard locker
11	6	66	Standard locker

BUZZBOX MFC door steel lockers

Add a new level of style to contemporary spaces such as offices, schools, retail and leisure environments with **BUZZBOX**.

- Satin-finished doors with durable steel-body lockers, available in 1,2,3 & 4 compartment options.
- Doors and end panels comprise of a sturdy 18mm MFC core, laminated in a choice of fifteen contemporary colours.
- Steel body available in silver, white or black finishes.

Optional sloping top
Please request when ordering.

The optional sloping top, prevents the accumulation of rubbish.

End panels to match

End panels can be supplied to compliment the doors for either end of a locker run or for individual lockers.

Strength and style

The doors and end panels comprise of a sturdy **FSC certified 18mm MFC** core laminated in a choice of fifteen contemporary colours.



Numbering system

Available as an optional extra.

Number plates will be recessed into door if ordered with lockers.

Soft close hinges

Hinges open through a wide 164° for ease of access and are damped for soft closure.



See **page 36** for colour options.



See **pages 44** for locking options.



Single compartment

Fixed top shelf with double coat hook.

- W 305 x D 323 mm
- W 305 x D 478 mm
- W 380 x D 398 mm

Two compartment

Double coat hook per compartment.

- W 305 x D 323 mm
- W 305 x D 398 mm
- W 305 x D 478 mm
- W 380 x D 398 mm

Three compartment

- W 305 x D 323 mm
- W 305 x D 478 mm
- W 305 x D 398 mm

Four compartment

- W 305 x D 323 mm
- W 305 x D 398 mm
- W 305 x D 478 mm
- W 380 x D 398 mm





TIMBERBOX MDF door steel lockers

A favourite across the leisure industry, the wood-effect laminate doors offer a sleek storage solution for any environment.

- Manufactured from durable MDF, **TIMBERBOX** is available in four timber-effect door finishes.
- Available in two body colours.
- Standard steel body with 1,2,3 & 4 compartment options to choose from.



Soft close hinges

Hinges open through a wide 164° for ease of access and are damped for soft closure.

End panels to match

End panels can be supplied to compliment the doors for either end of a locker run or for individual lockers.



Numbering system

Available as an optional extra.
Number plates will be recessed into door if ordered with lockers.

Choice of locks

Strength and style

The doors and end panels comprise of a sturdy **18mm MDF** core laminate with 2mm PVC edging.

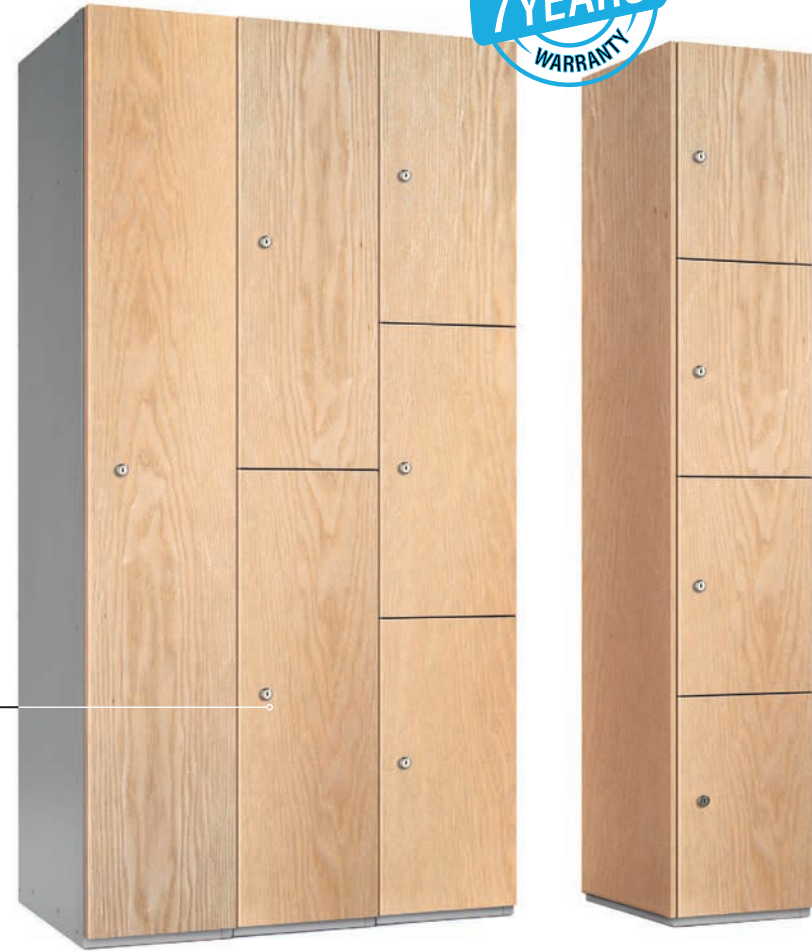

See **page 36** for colour options.



See **pages 44** for locking options.

AC+IVECOAT

ActiveCoat technology as standard.



Single compartment

Fixed top shelf with double coat hook.

W 305 x D 323 mm
W 305 x D 478 mm
W 380 x D 398 mm

Two compartment

Double coat hook per compartment.

W 305 x D 323 mm
W 305 x D 398 mm
W 305 x D 478 mm
W 380 x D 398 mm

Three compartment

W 305 x D 323 mm
W 305 x D 478 mm
W 305 x D 398 mm

Four compartment

W 305 x D 323 mm
W 305 x D 398 mm
W 305 x D 478 mm
W 380 x D 398 mm



MFC & MDF door colour finishes

BUZZBOX MFC Satin stock finishes

Door finish



Grey

White

Body colours



White
RAL 9016

Black
RAL 9004

Silver
RAL 9006

BUZZBOX MFC Satin non-stock finishes

Door finish



Fresh
Green

Lemon

Candy
Red

Goldfish
Orange

Light
Beige

Black

Anthracite

MDFTIMBERBOX & Golf locker door finishes shown with White body

18mm MDF core laminated doors with steel body.



Walnut

Beech

Maple

Oak

Optional body colour



Silver
RAL 9006



Please note that due to printing restrictions colours represented may differ from original product. We recommend you request a colour swatch before ordering.

Locker accessories

Sloping tops



Ideal in hygiene sensitive locations, sloping tops prevent items and litter from accumulating on locker tops.

- Makes cleaning easier.
- Choose from factory-fitted or retrofit.
- Available on all standard lockers.

Cloakroom units

Fitted between adjacent lockers, cloakroom units offer even more storage space.

- Top units incorporate a central full-length hanging rail.
- Quarto or Sixto lockers can be placed on top for additional storage space.
- Base units include a free standing rack to support footwear or other items 150mm above the floor.



Locker stands



Locker stands provide maximum access to floor space in areas where floors need frequent cleaning,

- Manufactured using 25mm square tubes.
- All locker stands come with adjustable feet.
- Available on all standard lockers.
- Stand height 150mm.

Captive coat hangers



Specified at the time of order, captive coat hangers cannot be removed, preventing theft and accidental loss.

- Factory fitted.
- Available for all lockers and cloakroom units with hanging rails.

Locker stand & bench

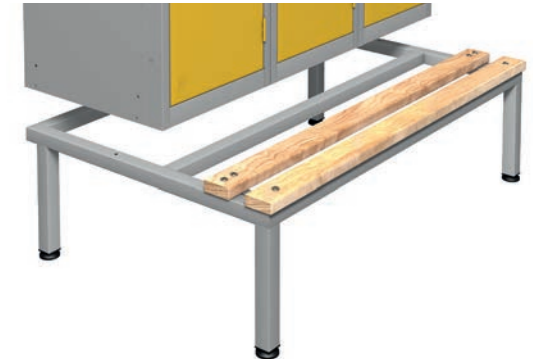

Ideal in changing rooms, lockers stands and benches provide users with secure storage whilst offering bench seating.

- Full access to the locker.
- Units come complete with adjustable feet.
- Two beech slats and metal framework form a bench seat.
- Stand height 400mm.

Numbered key fobs



Made in various coloured plastic and engraved and printed to any number and/or alpha character of your choice.

SHOCKBOX laminate door dry area lockers

With durable laminate doors that are less likely to scratch, dent or be damaged, **SHOCKBOX** is suited to dry areas that receive high volumes of traffic and use.

- Available in a range of colours.
- Choose from our Standard Range or specify a laminate to match your architectural design.



Inset doors

Provide a visual contrast between the door finish and the locker frame.



Overlay doors

Cover the front face of the locker body, creating a wall of colour.



See **page 43** for colour options.



See **pages 44** for locking options.

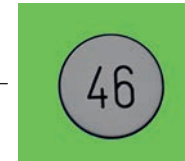

Numbering system

Optional number plates will be recessed into door if ordered with lockers.

HINGE SECURING PLATE

This strong hinge incorporates an integral securing plate which clamps the door to the hinge giving added security.

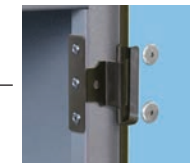

180° hinge

Hinges open through a wide 180° for ease of access.

Welded shelf plinth

High security welded compartment divider incorporating internal door stop and sill.

Laminate doors are available in a vast range of contemporary colours from leading manufacturers. Choose from our Standard Range or specify a laminate to match your architectural design.



Formica and the Formica anvil device are registered trademarks of The Diller Corporation.

Available with sloping tops.



Z Locker - overlay door only
Double coat hook per compartment.
W 380 x D 460 mm



Available in 1, 2, 3 and 4 compartments and low 2 compartment with Inset or Overlay doors.

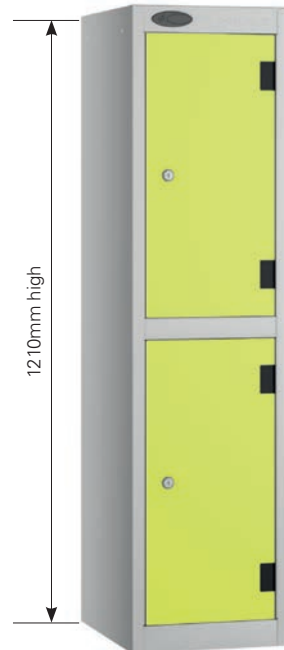

Low Two compartment
W 305 x D 460/470 mm



Single compartment	Two compartment	Three compartment	Four compartment
Fixed top shelf with double coat hook.	Double coat hook per compartment.		
		W 305 x D 380/390 mm	W 305 x D 460/470 mm

End panels to match the doors

End panels can be manufactured to add on to the end of locker runs or to the side of each individual locker if required.

ZENBOX aluminium wet area lockers

Designed and engineered ZENBOX lockers are the perfect choice for demanding environments.

ZENBOX lockers are designed and engineered to withstand the rigours of high use wet area environments where the requirements of design with durability and image are paramount.



End panels to match doors

End panels can be manufactured to add on to the end of locker runs or to the side of each individual locker if required.



Numbering system

Optional number plates will be recessed into door if ordered with lockers.

Aluminium Body

Aluminium shelves, fixed firmly into position adding rigidity to the locker. Aluminium body with reduced radius corners give full width shelf to back of locker and aid cleaning.

Extensive range of lock options

A range of quality engineered locks available for wet, humid or dry environments.

10mm Solid Grade Laminate (SGL) doors

Super strong and stylish doors available in many contemporary colours.

Precision Engineered

All lockers are supplied fully assembled and can be nested side by side with no visible gaps.

Single compartment

Fixed top shelf with double coat hook.

Two compartment

Double coat hook per compartment.

Three compartment

Four compartment

Six compartment

Available in 1, 2, 3, 4 and 6 compartments

- W 300 x D 400 mm
- W 300 x D 450 mm
- W 300 x D 500 mm
- W 400 x D 400 mm
- W 400 x D 450 mm



See **page 43** for colour options.



See **pages 45** for locking options.



ZENBOXULTRA outdoor locker

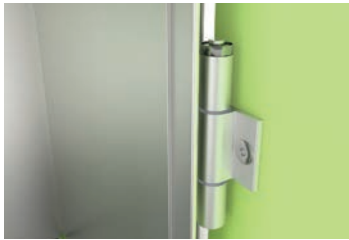

Heavy duty self-closing hinges engineered to prevent the doors opening across adjacent compartment.

Incorporating all the benefits of the standard ZENBOX locker, ZENBOXULTRA features solid grade laminate doors and added door seals, making them the perfect choice for:

- Leisure Centres
- Swimming Pools
- Schools
- Gyms
- Spas
- Outdoor areas

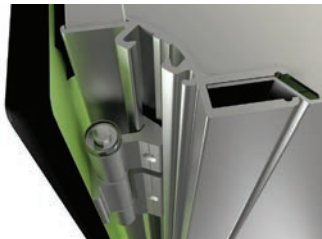

Concealed hinge within extruded aluminium frames engineered for added strength and stability.

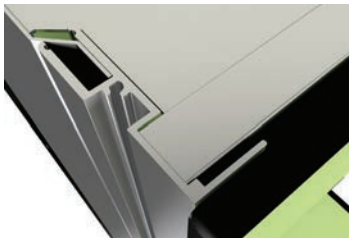

Flush frame for zero gap when lockers are nested.



End panels to match doors

End panels can be manufactured to add on to the end of locker runs or to the side of each individual locker if required.



Integral door seal

This seal ensures there is no water ingress into the locker compartment.

Available in 1, 2, 3, 4 and 6 compartments

- W 300 x D 400 mm
- W 300 x D 450 mm
- W 300 x D 500 mm
- W 400 x D 400 mm
- W 400 x D 450 mm

ZENBOX accessories

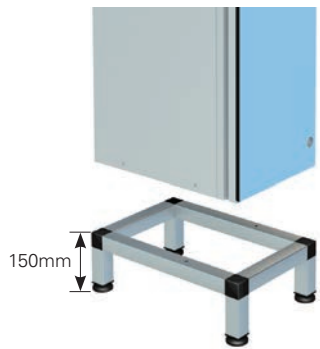

Adjustable feet

All support stands come with adjustable feet for sloping floors.

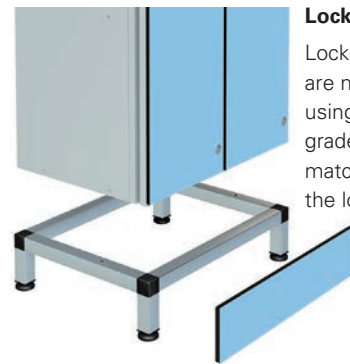

Locker stand plinths

Locker stand plinths are manufactured using 10mm Solid grade laminate (SGL) to match or contrast with the locker doors.

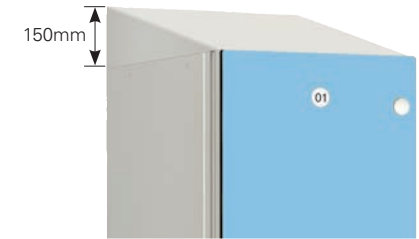
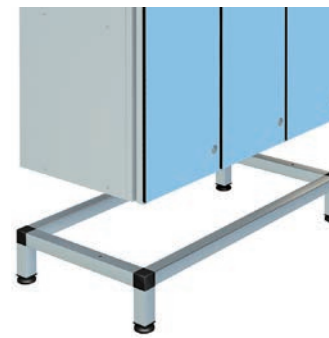

Sloping Top

Sloping tops are a good way of preventing litter, bags and other items being left on top of the lockers. The sloping top also makes cleaning easier. Sloping tops are essential in hygiene – sensitive applications such as the NHS or food preparation.

Aluminium Locker Support Stands

Locker support stands raise lockers off the floor, reducing impact damage and making cleaning easier. Manufactured from 25mm square aluminium section they are ideal for wet environments.

All units come complete with adjustable feet to aid levelling on uneven floors.

Optional 10mm solid grade laminate (SGL) plinth available to match or contrast with the locker doors.

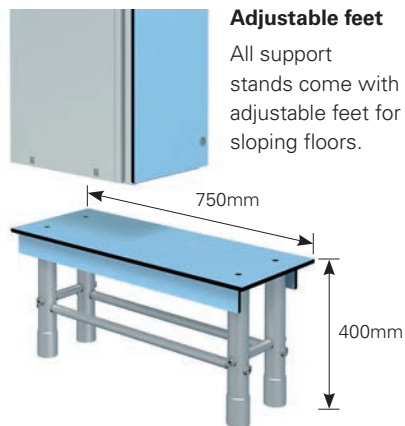

Adjustable feet

All support stands come with adjustable feet for sloping floors.



Locker seat plinths

Locker seat plinths are manufactured using 10mm solid grade laminate (SGL) to match or contrast with the locker doors.



Numbering System

Optional inset number plates are available. Discs are recessed into the door. Request when placing order.

Aluminium Seats and Stands

10mm solid grade laminate seat (SGL) and 45mm aluminium framework form a bench seat in front of the locker, allowing full access to the locker.

Seat can match or contrast with the locker door or with an optional SGL plinth.

All units come complete with adjustable feet to aid levelling on uneven floors.

Laminate door colour options

SHOCKBOX stock 10mm SGL door finishes - steel Silver body. Choice of inset or plant-on doors.

ZENBOX and ZENBOXULTRA stock 10mm SGL door finishes - aluminium body



Create a storage solution that closely matches your branding or blends subtly into the background with a range of coloured door options to choose from.

Choose from our Standard range or specify a laminate to match your architectural design.



Formica and the Formica anvil device are registered trademarks of The Diller Corporation.

Solid grade laminate with fire classification available at additional cost.

Please ask us for further information on fire classifications and applications.



SHOCKBOX, ZENBOX and ZENBOXULTRA additional door colour 10mm SGL door finish options are below, available on an extended lead time.

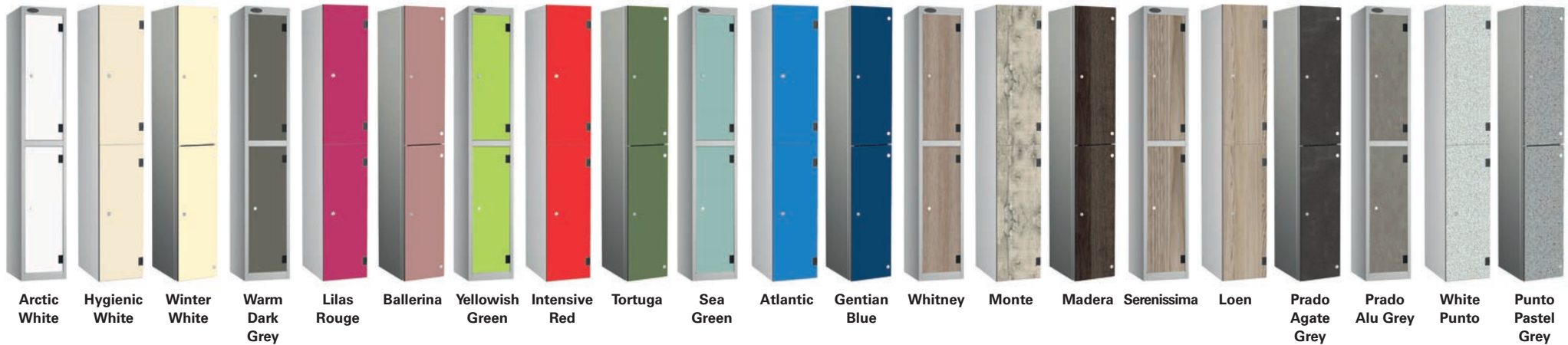

Please note that due to printing restrictions colours represented may differ from original product. We recommend you request a colour swatch before ordering.

Lock options

Dry area locks



Type A
Probe cam lock*

Even the standard lock has a micro sprung 10 disc lock featuring a massive 3000 serial combinations - all exclusive to Probe. Two keys are included with each standard lock.



Type B
Hasp and staple*

Attractive design allowing easy use of padlock fitting. Shank diameter maximum 7mm and minimum 5mm. Padlock sold separately.

Replacement hasp & staple

This Hasp & Staple is available to purchase separately if you need to change your existing lock.



Type C
Radial pin lock - 10,000 combinations

This Radial Pin Lock is designed for greater levels of security. Two keys are included with each lock.



Type P
Re-programmable combination lock

User re-programmable 4 digit code combination lock with 10,000 possible combinations, making losing keys a thing of the past. Suitable for multi user applications. Master override key sold separately.

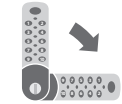

Type GM
Gemini 2700 mechanical combination lock

This small and innovative lock is available in both flush and surface mount and in a silver or black finish. Master override key sold separately.

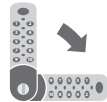

Type GD
Gemini 3700 digital combination lock

This small and innovative lock is available in both flush and surface mount and in a silver or black finish. Master override key sold separately.

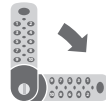

Type L
Digital combination lock 40,000 combinations

Simple to program battery operated lock which can last up to 50,000 operations before needing changing. Emergency access using service key. Single user supplied as standard but multi-user option is available (specify when ordering).

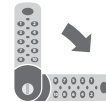

Type N
Nimbus RFID lock

The Nimbus RFID digital lock provides contactless locking and is compatible with RFID standards and incorporates a membrane touch pad for ease of programming. The keypad can also be used to override the lock when required.



Type H-£1
Dual coin/token Return/Retain

These locks are available with coin denominations £/€ or tokens, for either return or retain.



Type K-W **Type K-B**
Mechanical reprogrammable lock with 10,000 combinations

These locks are easy to use and features a master key override (supplied separately). Available in black or white finish.



Type SPU - Public
Type SPR - Private

Public multi-user auto scramble combination lock

Automatically scrambles to 0000 when opened. Has 999 highly secure combinations available - no batteries needed. It has a metal matte black shell and has a master key override (supplied separately) for code finding and lock resetting.

These locks can be mounted **VERTICALLY**. Subject to minimum order quantity. Specify when ordering.

Wet area locks



Type 3
Probe cam lock*

Even the standard lock has a micro sprung 10 disc lock featuring a massive 3000 serial combinations- all exclusive to Probe. Two keys are included with each standard lock.



Type 2
Hasp and staple*

Attractive design allowing easy use of padlock fitting. Shank diameter maximum 7mm and minimum 5mm. Padlock sold separately.

Replacement hasp & staple

This Hasp & Staple is available to purchase separately if you need to change your existing lock.



Type 11
Re-programmable combination lock

User re-programmable. An effective 4 digit code combination lock with 10,000 possible combinations, making losing keys a thing of the past. Suitable for multi user applications. Master override key sold separately.

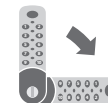

Type 6
Digital combination lock
40,000 combinations

Simple to program battery operated lock which can last up to 50,000 operations before needing changing. Emergency access using service key. Single user supplied as standard but multi-user option is available (specify when ordering)**Can be used vertically**

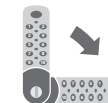

Type 10
The RFID keyless digital combination lock

This lock provides contact less RFID locking and can be used independently or paired with existing wireless systems. Simple to upgrade existing installations and compatible with most wireless standards including RFID and NFC, the lock comes with a wide range of accessories and options.



Type 8
Waterproof coin/token Return/Retain lock

These Waterproof and Chlorine resistant locks are available with coin denominations £/€ or tokens, for either return or retain..

Premium cloakroom seating

Comprehensive range of easy-to-install cloakroom units, with a wide choice of options and accessories, ensuring you will find exactly what you are looking for. All units are available in a choice of five exciting colours to match your interior.

- Hook Bench and Benches are available with three seat heights, **Infant**, **Junior** and **Senior**, making them the perfect solution for schools; whatever age group they teach.
- Frames are constructed from robust 50mm round, thick wall tubing with welded joints for strength and durability.
- Adjustable feet fitted to all floor standing units.



Beech Solid Timber Slats

Sourced from sustainable forests.



Black Polymer Slats

Manufactured with an antibacterial finish; these food grade slats are ideal for educational or leisure wet area changing areas.

AC+IVECOAT

ActiveCoat technology as standard.

Standard Frame Colours

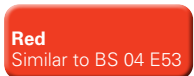

Red
Similar to BS 04 E53



Blue
Similar to RAL 5019



Yellow
Similar to RAL 1004



Green
RAL 6018



White
RAL 9016

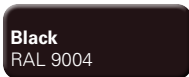

Black
RAL 9004

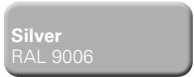

Silver
RAL 9006

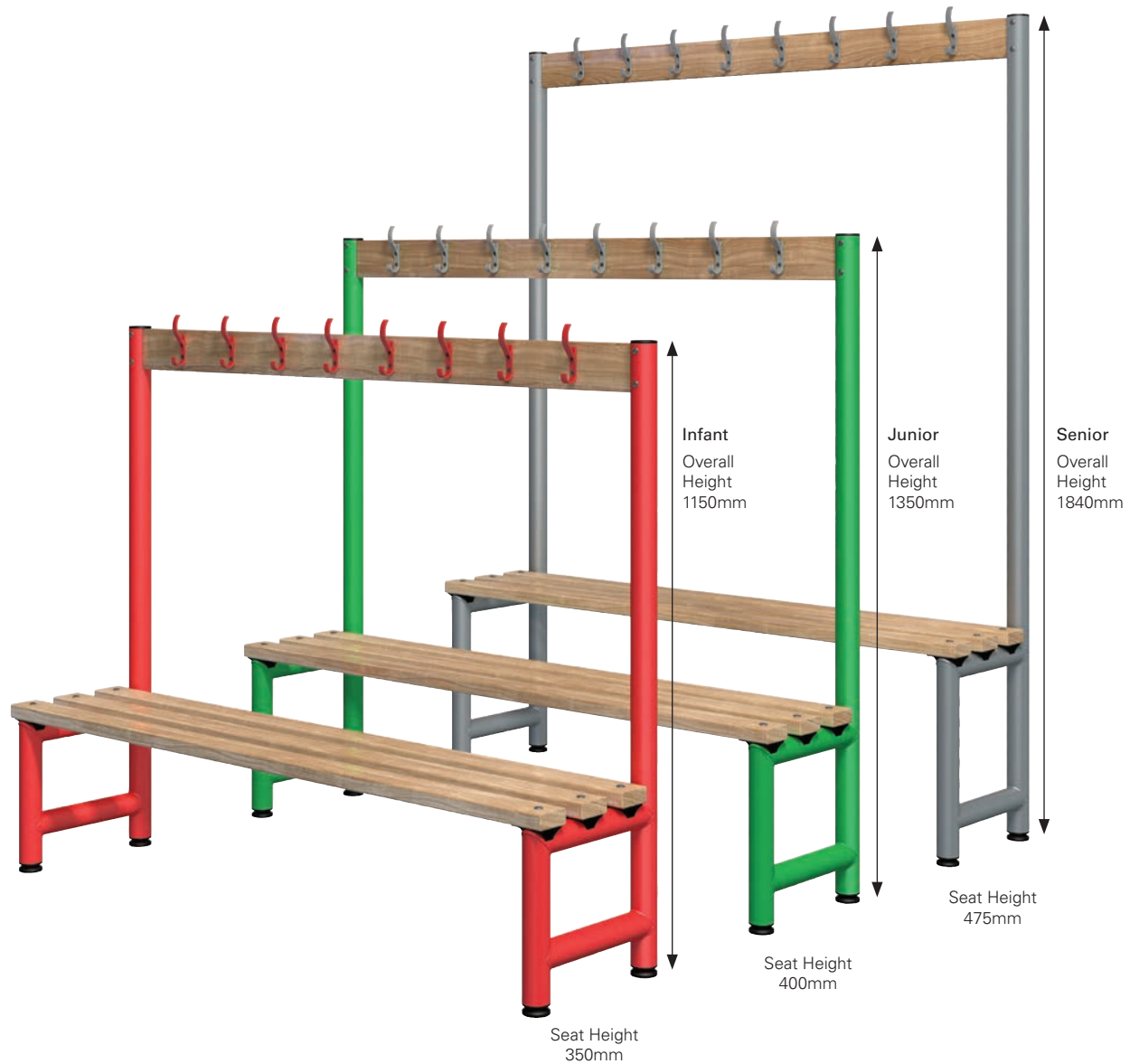

Hook bench

Strong and robust hook bench for changing rooms, cloakrooms etc. Choice of single or double sided units with 5, 8, 10, 16 or 20 hooks. Single-sided bench is ideal up against the perimeter wall while the double unit fits perfectly in the middle of the room.

- Beech or black polymer slats.
- Choice of three seat heights, makes them the perfect solution for schools; whatever age group they teach.
- These virtually unbreakable, polymer coat hooks, have been ergonomically designed and contain ActiveCoat technology.



Silver & green frames have silver hooks while WHITE frames feature black hooks.



Red, blue, black & yellow frames are available with matching coloured hooks.



Single sided Black Polymer
2000mm wide hook bench
W 1000 x D 375 mm
W 1500 x D 375 mm
W 2000 x D 375 mm



Double sided Beech 2000mm wide
hook bench
W 1000 x D 710 mm
W 1500 x D 710 mm
W 2000 x D 710 mm

Slatted bench

Ideal for sporting, medical, education or industrial changing areas, free-standing cloakroom benching is an integral part of any changing room facility.

- Beech or black polymer slats.
- Choice of three seat heights, **Infant, Junior** and **Senior** makes them the perfect solution for schools; whatever age group they teach.
- Complete with adjustable feet.



Double sided Beech 2000mm bench

- W 1000 x D 710 mm
- W 1200 x D 710 mm
- W 1500 x D 710 mm
- W 2000 x D 710 mm



Single sided Beech 1200mm wide bench

- W 1000 x D 710 mm
- W 1200 x D 710 mm
- W 1500 x D 710 mm
- W 2000 x D 710 mm

Senior
Seat Height
475mm

Junior
Seat Height
400mm

Infant
Seat Height
350mm

Overhead bench

Designed for use in gyms, sports & leisure centres or changing areas, overhead hanging bench seating allows garments to be hung up while shoes and sports bags are neatly stored on the top shelf above.

- Beech or black polymer slats.
- Seat height 475mm.
- Unit height 1840mm.
- Complete with adjustable feet.



Single sided Beech
1500mm wide overhead
hanging bench

- W 1000 x D 375 mm
- W 1500 x D 375 mm
- W 2000 x D 375 mm

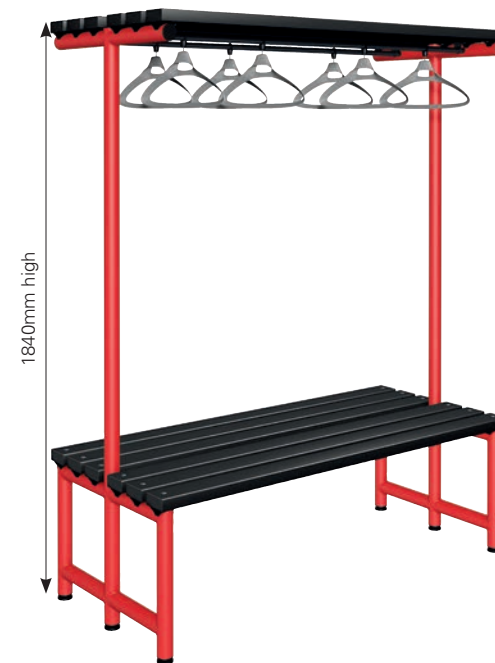

Double sided Black
Polymer 1500mm wide
overhead hanging bench

- W 1000 x D 710 mm
- W 1500 x D 710 mm
- W 2000 x D 710 mm

Cloakroom options



Our range of seating and benching also includes a range of cantilever units, seat & stands and seat units; all of which can be used to enhance the changing room experience.



Wall Hook Strip

- Beech or Black Polymer strips.
- Black Polymer strips are fitted with grey hooks (unless stated otherwise).
- Wall fixings NOT included.



Shoe Baskets

- Provides extra space by utilising under bench space.
- Silver grey- fixings NOT included.
 - 305mm in height.



Low Seats

- Single or Double sided

Wall Mounted Shelf & Rail



Wall Mounted Cantilever Seating



Cupboards

We have an extensive collection of storage cupboards suitable for a range of commercial and office environments.

These cupboards are manufactured in the UK in a range of heights, widths and internal configurations to meet a wide variety of applications in the workplace.

Available in 3 colours along with 6 bright door colours to fit into any workplace.

Choice of 2 shelf loadings – **65kg** or **85kg** (UDL) – allowing you tailor your shelf capacity to the items being stored. This is further enhanced as shelves sit on clips allowing the shelf pitch to be adjusted in 25mm increments to accommodate taller items.

Door frames manufactured from 1.0mm mild steel, doors 0.9mm, body and panels from 0.7mm.



ACTIVECOAT

All painted components are protected with a powder coating which incorporates ActiveCoat anti-bacterial technology.

ActiveCoat has been tested by an Internationally recognised microbiological testing laboratory for antibacterial performance, against the most widely encountered and problematic organisms including the MRSA Super bug and E-coli. These micro-organisms suffered a 99.9% reduction in population.



Two point locking mechanism

Shelves are available in TWO load duties, **65kgs** for office applications and **85kgs** for industrial environments

Shelves sit on 4 shelf clips and are adjustable on 25mm pitch. Additional shelves available.



Ergonomic lock protects cupboard from key scratching and features a 10 disc lock with 3000 serial combinations. Supplied with 2 keys.

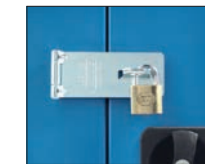

Factory fitted optional security hasp for padlock fitting is available

Compartment and wardrobe cupboards feature fixed vertical dividers pierced for shelf clips.

Welded internal full height door strengthener

Workplace Cupboards

A range of steel cupboards designed to meet general and janitorial storage needs throughout the workplace, all available in a variety of sizes and configurations.

- Choice of 6 door colours with 3 body colours.
- Doors feature 2 point locking and full height stiffeners.
- Adjustable shelves carry 65kg UDL.

Low cupboard



Complete with 1 adjustable shelf- extra shelves available on request.

H 1015 x W 915 x D 460 mm - 1 shelf

Tool / Low cupboard

Tool cupboard features a dished top to help retain tools and small items.



Complete with 1 adjustable shelf- extra shelves available on request.

H 890 x W 460 x D 460 mm - 1 shelf

Open cupboard



Complete with 4 adjustable shelves.
H 1780 x W 915 x D 460 mm - 4 shelves

Standard door colours shown with Silver body



Blue
Similar to RAL 5019



Green
RAL6018



Red
Similar to BS 04 E53



Yellow
Similar to RAL 1004



Silver
RAL 9006



White
RAL 9016

Optional body colours



White
RAL 9016



Black
RAL 9004

Tall Workplace Cupboards

A range of 1780mm high steel cupboards designed to meet general and janitorial storage needs throughout the workplace, all available in a variety of sizes and configurations.

- Choice of 6 door colours with 3 body colours.
- Doors feature 2 point locking and full height stiffeners.
- Adjustable shelves carry 65kg UDL.
- Door frames manufactured from 1.0mm mild steel, doors 0.9mm, body and panels from 0.7mm.



Standard cupboard



Supplied with 3 adjustable full width shelves-
extra shelves available on request.

H 1780 x W 915 x D 460 mm

8 compartment cupboard



Incorporates a central partition with 6
adjustable shelves.

H 1780 x W 915 x D 460 mm

12 compartment cupboard



Features two partitions with 9 adjustable
shelves.

H 1780 x W 915 x D 460 mm



See **page 51** for colour options.

AC+IVECOAT

ActiveCoat technology as standard.

Janitor cupboard



A useful combination of shelves and garment storage is created by a central partition. One side has 3 adjustable shelves while the other has a single shelf with hanging rail.

H 1780 x W 915 x D 460 mm

Wardrobe cupboard



Complete with fixed full width shelf and hanging rail.

H 1780 x W 915 x D 460 mm

Slim wardrobe cupboard



Complete with single shelf and hanging rail.

H 1780 x W 610 x D 460 mm

Slim cupboard



Complete with 3 adjustable shelves.

H 1780 x W 610 x D 460 mm

Industrial cupboards with removable sumps

A range of robust cupboards with removable sumps for the allowing for the easy removal of spilled liquids.

- Adjustable shelves carry 85kg UDL.
- Range of cupboards with removable 75mm sealed sump base for the removal of spilled liquids. 460 wide sump holds 5.5litres, 915 wide sumps holds 11.25 litres.
- Doors feature 2 point locking and full height stiffeners.

Hazardous substance storage



Cupboards designed to store hazardous liquids safely. Doors are high visibility yellow with silver grey body.

All units comply with HFL/ LPG Reg 1972 Sec 5. HSE The Storage of Flammable Containers HS(G)51

Acid & alkali



White durable epoxy polyester coating giving a surface resistant to most acids and alkalis.

Toxic & pesticide



Red doors and silver grey body with high visibility labels complying with BS5609.

ACTIVECOAT

ActiveCoat technology as standard.

Low cupboard H 1015 x W 915 x D 460 mm - 1 shelf

Tall cupboard H 1780 x W 915 x D 460 mm - 3 shelves

Low cabinet H 890 x W 460 x D 460 mm - 2 shelves

Industrial cupboards



A range of robust cupboards for specific storage needs.

- Adjustable shelves carry 85kg UDL.
- Doors feature 2 point locking and full height stiffeners.

COSHH



Doors and body in silver grey with high visibility self write labels for you to personalise the contents.

- Low cupboard** H 1015 x W 915 x D 460 mm - 1 shelf
- Tall cupboard** H 1780 x W 915 x D 460 mm - 3 shelves
- Low cabinet** H 890 x W 460 x D 460 mm - 2 shelves

Medical



White body and doors with high visibility, 270 degree labelling, complying to BS5499-1.

- Low cupboard** H 1015 x W 915 x D 460 mm - 1 shelf
- Tall cupboard** H 1780 x W 915 x D 460 mm - 3 shelves
- Low cabinet** H 890 x W 460 x D 460 mm - 2 shelves
- Slim cupboard** H 1780 x W 610 x D 460 mm - 3 shelf
- Locker** H 1780 x W 460 x D 460 mm - 1 fixed -shelf
- Cube** H 460 x W 460 x D 460 mm - 1 shelf

PPE



Blue doors with silver grey body with high visibility 270 degree labelling, complying to BS5499-1.

- Low cupboard** H 1015 x W 915 x D 460 mm - 1 shelf
- Tall cupboard** H 1780 x W 915 x D 460 mm - 3 shelves
- Low cabinet** H 890 x W 460 x D 460 mm - 2 shelves
- Slim cupboard** H 1780 x W 610 x D 460 mm - 3 shelf
- Wardrobe** H 1780 x W 915 x D 460 mm - 4 shelves