

Axis locks with a touch RFID interface are operated by an RFID credential or by an ADA compliant User Key. Manager Keys provide management access and external power. Programming is accomplished via a Programming Key unique to the lock system. An optional mobile application tool simplifies lock system management and provides audit trail.

Lock Parts

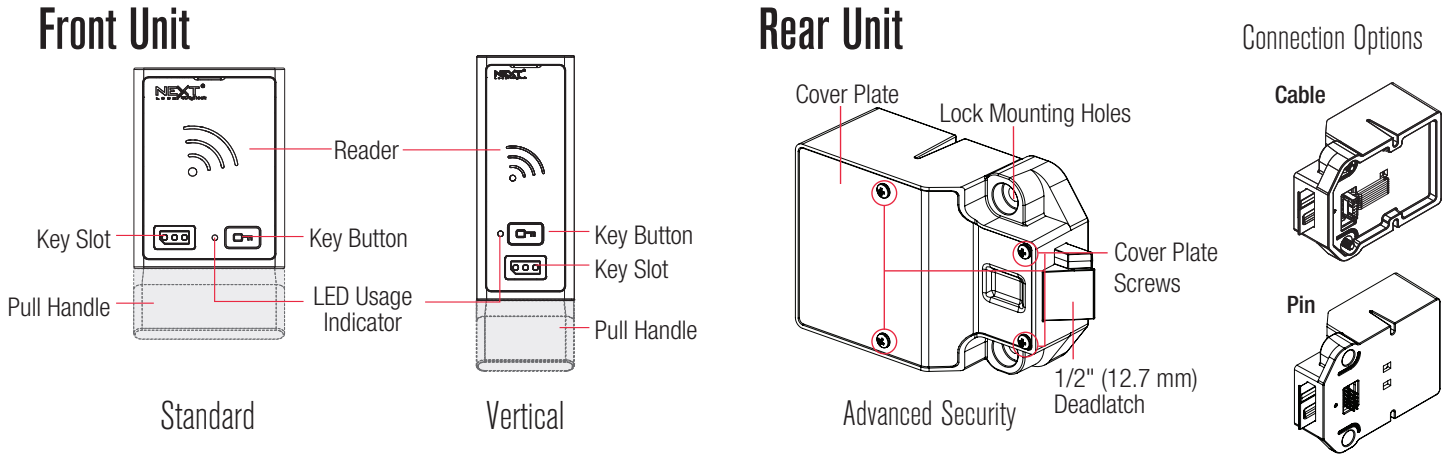

User Credential

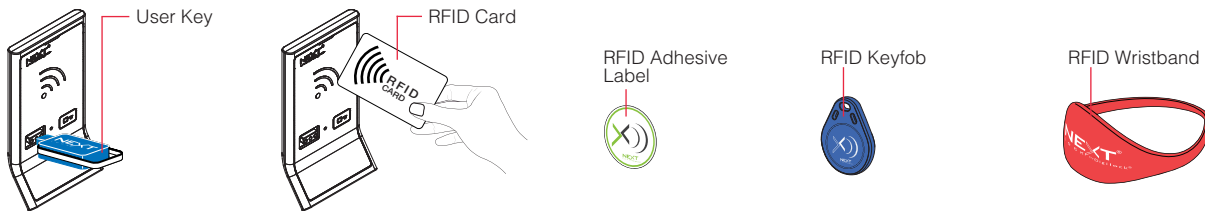

Keys



	User Key	Manager Key*	Programming Key**
Operates the lock	•	•	•
Overrides user access		•	•
Allows management inspection		•	•
Provides external power		•	
Registers Manager Keys			•
Assigns user credential		•	

*Up to 25 Manager Keys may be registered to each lock

**1 Programming Key allowed per lock system

Key Insertion



Next logo must face up on standard and vertical body locks.

Setup

Locks are shipped with factory default settings (only operates by pressing ) . Setup must be completed to register the Programming Key and Manager Keys to all the locks.

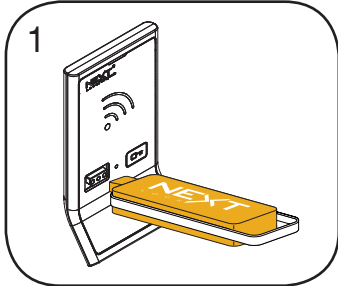

1
Insert the Programming Key.
A two-tone beep will be heard and the LED will turn on.

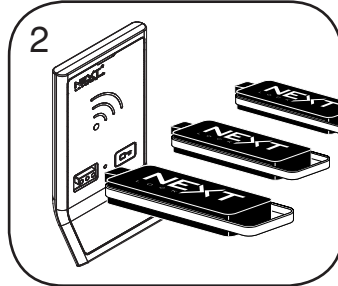

2
Insert one Manager Key at a time.
A two-tone beep will be heard for each Manager Key registered.

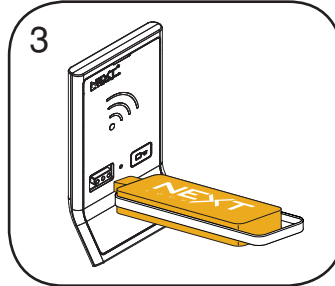

3
Insert the Programming Key.
A two-tone beep will be heard and the LED will turn off.

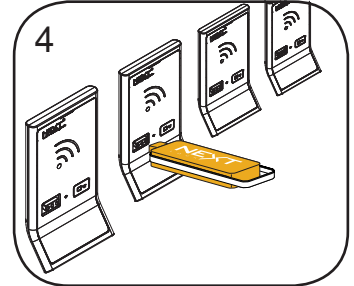



4
Repeat above steps for each lock or follow instructions to [Express Register Manager Keys](#) to setup all locks.

Programming Instructions

Express Register Manager Keys

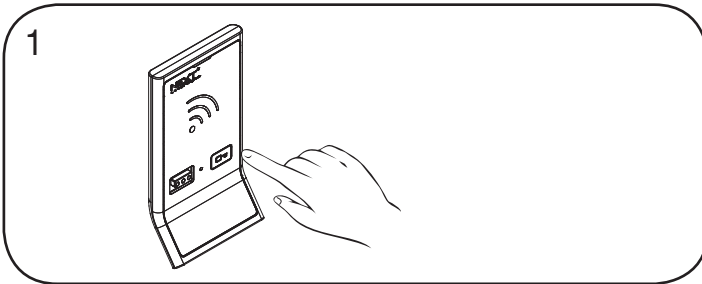
The Programming Key can quickly register the same Manager Keys to operate multiple locks.



1
Go to the lock already registered to operate with the Manager Keys.
Touch and hold  for 10 seconds until two sets of two-tone beeps are heard.
The LED will flash.

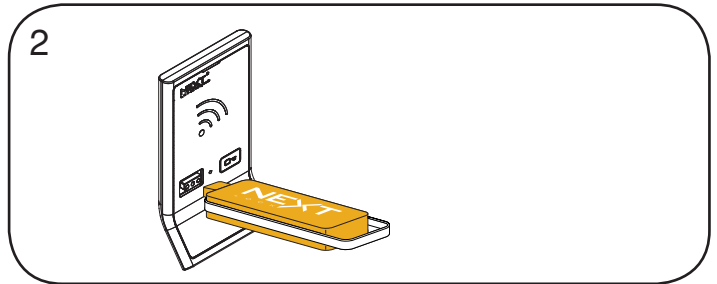

2
Insert the Programming Key.
A two-tone beep will be heard and the LED will turn off.

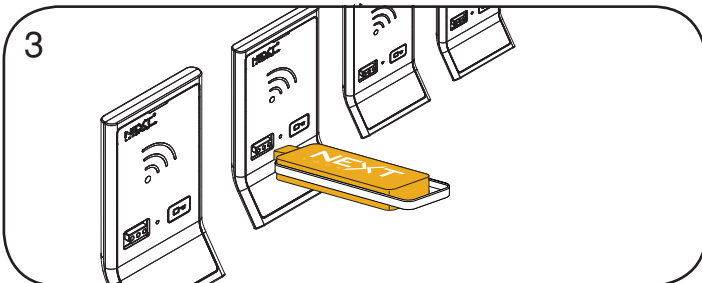

3
At each lock to be registered, insert the Programming Key.
A two-tone beep will be heard and the LED will flash once to indicate successful registration.

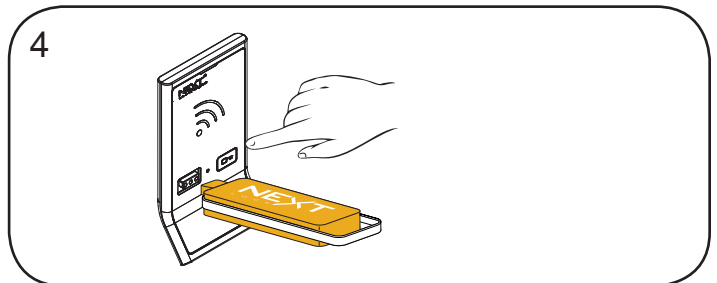

4
End express registration mode.
Go to any registered lock.
Touch  then insert the Programming Key.

Programming Instructions

Add Manager Keys

Manager Keys can be registered to the locks at any time.

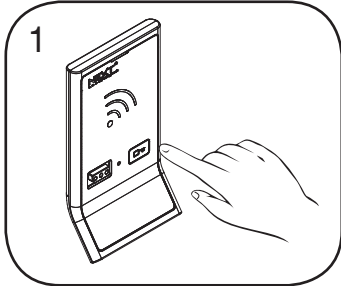

Go to a lock requiring additional Manager Keys.
Touch and hold **M** for 5 seconds until a two-tone beep is heard.
The LED will flash.

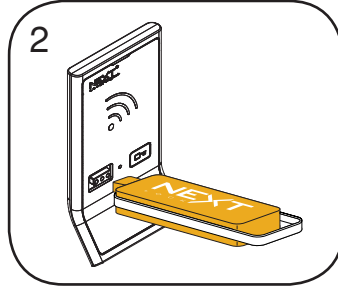

Insert the Programming Key.
A two-tone beep will be heard.

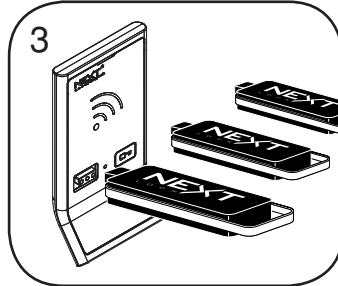

Insert each additional Manager Key one at a time.
A two-tone beep will be heard for each Manager Key registered.

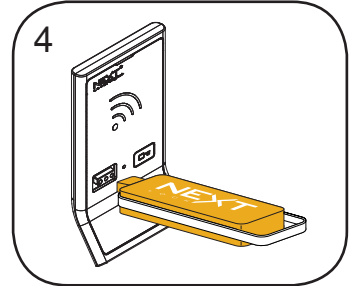

Insert the Programming Key.
A two-tone beep will be heard and the LED will turn off.
Repeat above steps for each lock or follow instructions to [Express Register Manager Keys](#) to register the same Manager Keys to multiple locks.

Replace Keys

Replacement keys must be purchased and registered to the locks to prevent the lost/stolen keys from operating a lock.

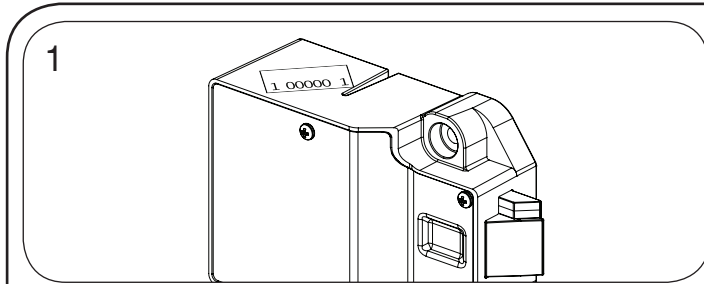

To replace the Programming Key:
Note the order number (found on the lock's rear unit).



Contact Digilock Support to purchase a replacement Programming Key.

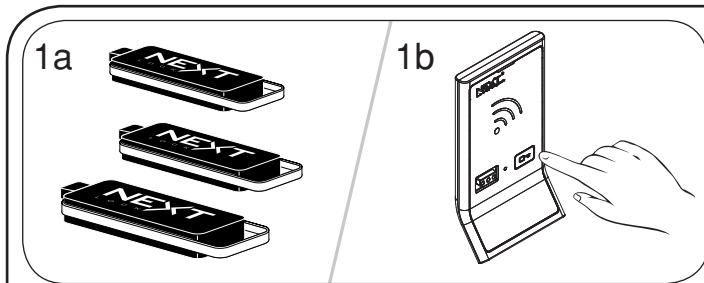

To replace the Manager Keys:
Collect all remaining Manager Keys.
Go to any lock operated by the Manager Keys.
Touch and hold **M** for 5 seconds until a two-tone beep is heard.

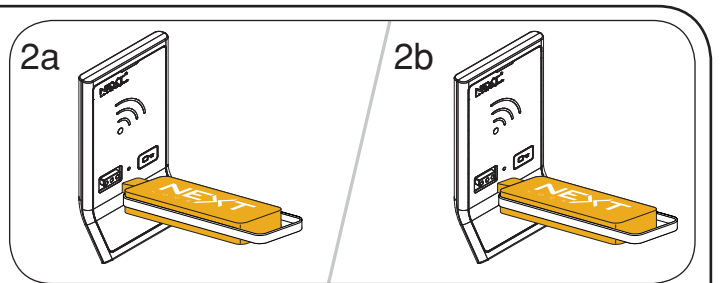



Insert the Programming Key.
A two-tone beep will be heard and the LED will turn on.
Insert the Programming Key again.
Three sets of two-tone beeps will be heard and the LED will turn off. All previously registered Manager Keys are erased.
Follow instructions to [Add Manager Keys](#) to register the remaining Manager Keys to the locks.

Programming Instructions

Assign the User Credential

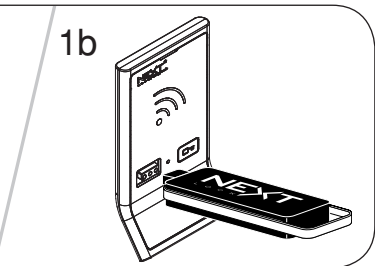
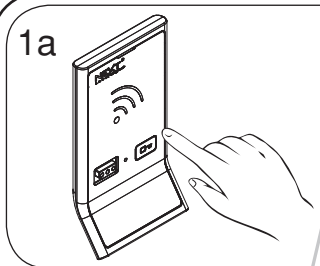
Once a user credential is assigned, the previously assigned user credential will no longer operate the lock.





Assign a User RFID credential:
Touch and hold **M** for 5 seconds until a two-tone beep is heard.
The LED will turn on.
Insert a registered Manager Key.
A two-tone beep will be heard.

Present the RFID credential to the RFID reader.
Two sets of two-tone beeps will be heard and the LED will turn off.

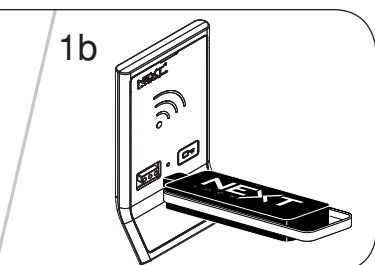
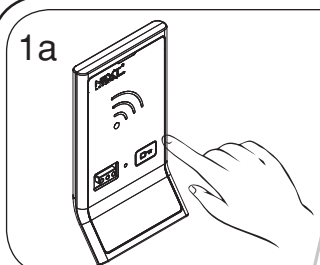



Assign a User Key:
Touch and hold **M** for 5 seconds until a two-tone beep is heard.
The LED will turn on.
Insert a registered Manager Key.
A two-tone beep will be heard.

Operating Instructions - In Assigned Use Functionality

In assigned use functionality, users unlock their assigned locker with either their assigned RFID credential or User Key. To reassign a locker to a different user, follow instructions to [Assign the User Credential](#).

1

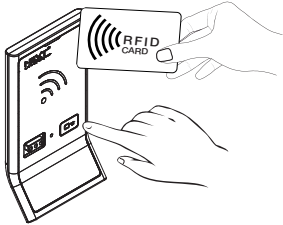

Operate with the RFID credential

To unlock: Touch  then present the assigned RFID credential.
To relock: Close the door.

1

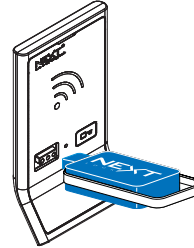

Operate with the User Key

To unlock: Insert the assigned User Key.
To relock: Close the door.

1

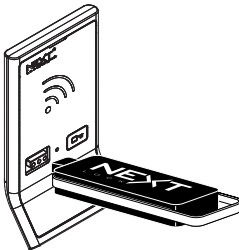

Operate with a Manager Key

To unlock: Insert a registered Manager Key.
To relock: Close the door.

1



Operate with the Programming Key

To unlock: Touch  then insert the Programming Key.
To relock: Close the door.

Support

Error Condition Indicators

10 rapid beeps:

The lock is binding which means that either door alignment or items in the locker are preventing the lock from operating. Press on the door while operating the lock. If error condition persists, contact Digilock support for assistance.

2 sets of three beeps:

The batteries are low. Replace the batteries.

Does not Unlock with the RFID credential or User Key

The lock does not recognize the RFID credential or User Key. For immediate access, operate with a registered Manager Key. Follow instructions to [Assign the User Credential](#) to assign a new user credential to the lock.

Does not Operate with a Manager Key

The lock does not recognize the Manager Key. Follow instructions to [Add Manager Keys](#) to register the Manager Key to the lock. For immediate access, operate with another registered Manager Key or with the Programming Key.

Does not Operate with the Programming Key

The lock does not recognize the Programming Key. If the Programming Key has been replaced, operate with the Replacement Programming Key. Contact Digilock support for additional assistance.

No Audible Feedback when is Pressed

- The batteries may need to be replaced. For immediate access, operate with a registered Manager Key.
- The front unit may not be properly connected to the rear unit. Remove the lock from the door and check the connection.

Battery Replacement (shown with cable rear unit)

It is not necessary to uninstall the lock from the door.

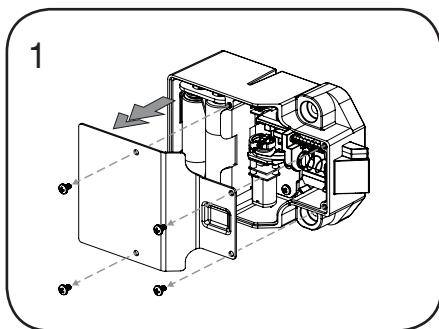

Remove the screws and the cover plate.

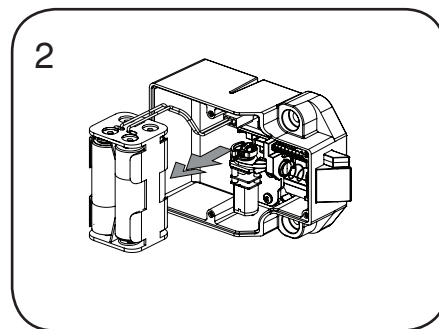

Pull the battery pack from the rear housing. Replace with four premium alkaline AA batteries.

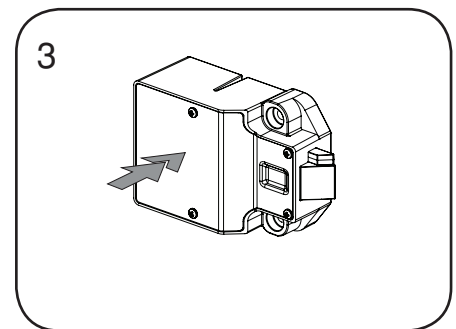

Place the battery pack back into the rear housing and screw cover plate in place.