

Axis locks with a keypad interface are operated by a 4-digit User Code or by an ADA compliant User Key. Manager Keys provide management access and external power. Programming is accomplished via a Programming Key unique to the lock system. An optional mobile application tool simplifies lock system management and provides audit trail.

Lock Parts

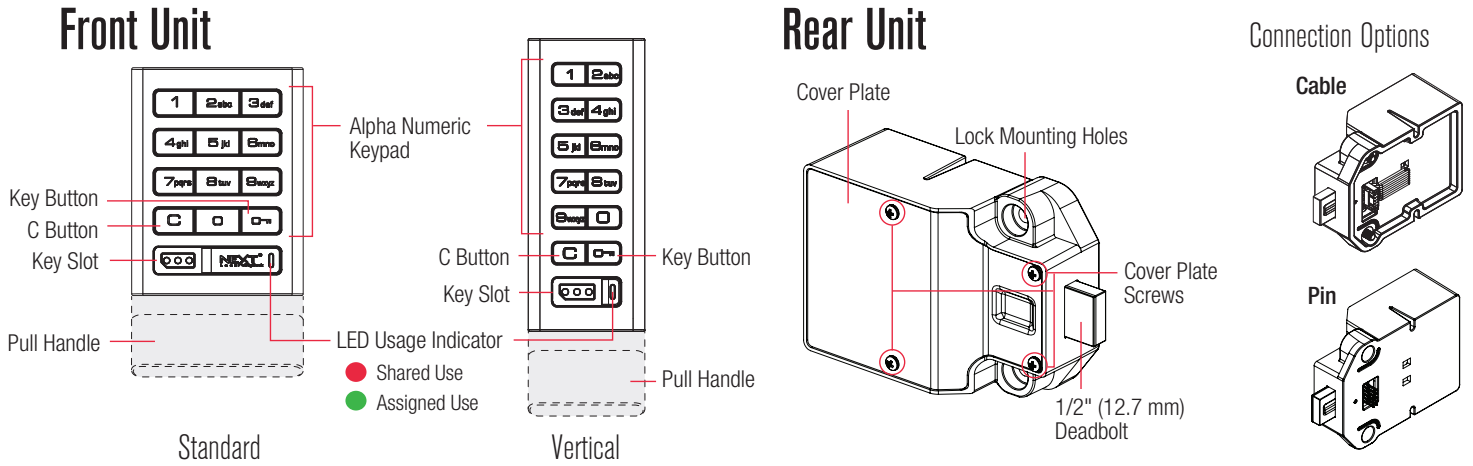

Keys



User Key



Manager Key*



Programming Key**

| | | | |
|---|---|---|---|
| Operates the lock | • | • | • |
| Overrides user access | | • | • |
| Allows management inspection | | • | • |
| Provides external power | | • | • |
| Registers Manager Keys | | | • |
| Assigns user credential (in assigned use functionality) | | • | |
| Sets lock functionality | | | • |

*Up to 25 Manager Keys may be registered to each lock

**1 Programming Key allowed per lock group

Key Insertion

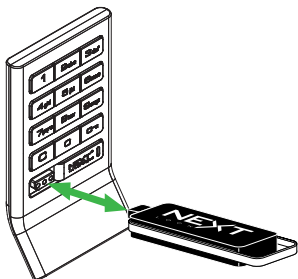

Standard

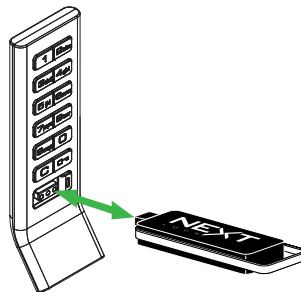

Vertical

Next logo must face up on standard and vertical body locks.

Setup

Locks are shipped with factory default settings (only operates by pressing \square \square). Setup must be completed to register the Programming Key and Manager Keys to all the locks.

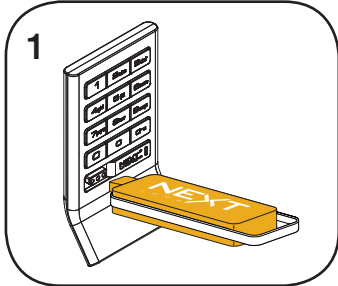

1
Insert the Programming Key.
A two-tone beep will be heard and the LED will turn on.

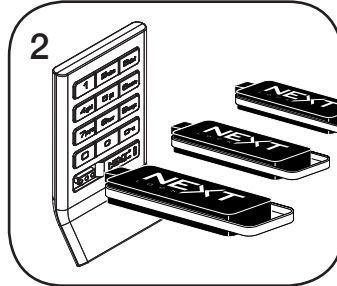

2
Insert one Manager Key at a time.
A two-tone beep will be heard for each Manager Key registered.

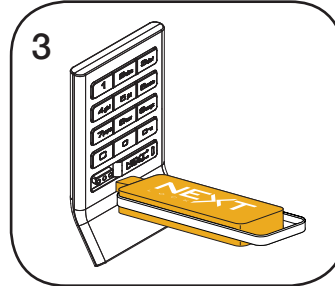

3
Insert the Programming Key.
A two-tone beep will be heard and the LED will turn off.

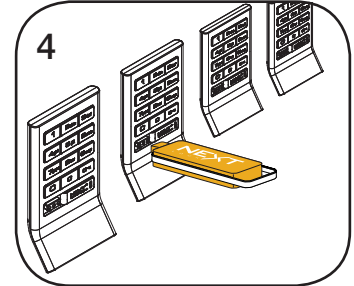

4
Repeat above steps for each lock or follow instructions to [Express Register Manager Keys](#) to setup all locks.

Programming Instructions

Express Register Manager Keys

The Programming Key can quickly register the same Manager Keys to operate multiple locks.

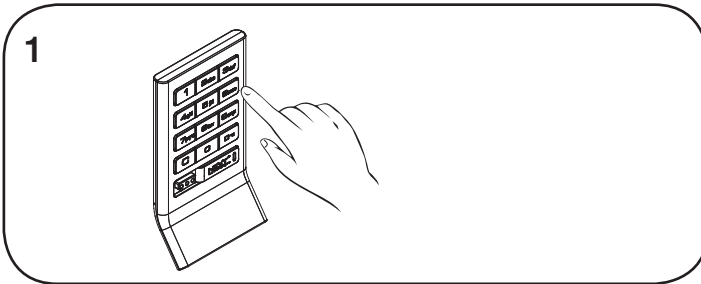

1
Go to the lock already registered to operate with the Manager Keys.
Press \square \square \square \square .
The LED will turn on.

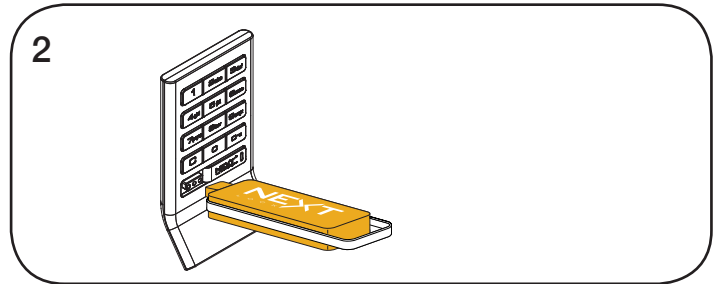

2
Insert the Programming Key.
A two-tone beep will be heard and the LED will turn off.

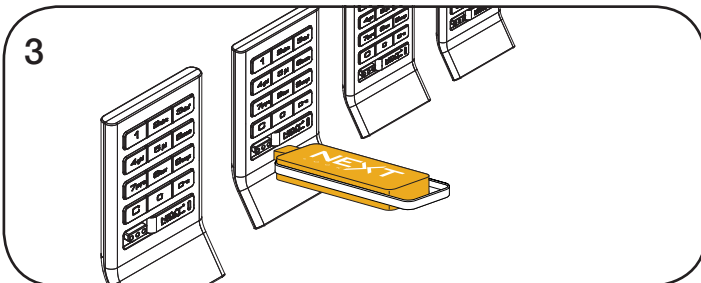

3
At each lock to be registered, insert the Programming Key.
A two-tone beep will be heard and the LED will flash once to indicate successful registration.

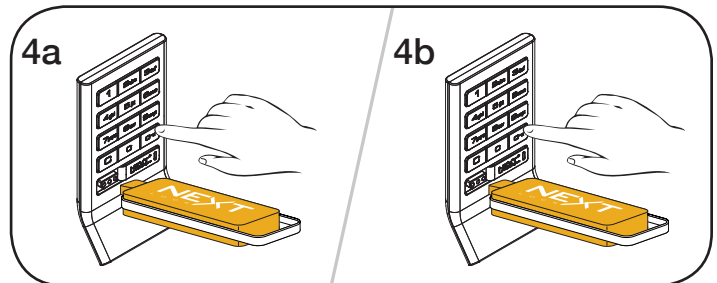

4a
End express registration mode.
Go to any registered lock.
Press \square \square then insert the Programming Key.
Press \square \square then insert the Programming Key again to return the bolt to the original position.

Programming Instructions

Add Manager Keys

Manager Keys can be registered to the locks at any time.

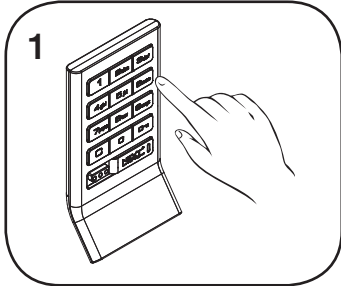

1
Go to a lock requiring additional Manager Keys.
Press **[C]** **[0]** **[5]** **[5]** **[0]**.
The LED will turn on.

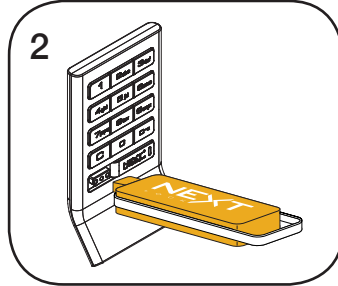

2
Insert the Programming Key.
A two-tone beep will be heard.

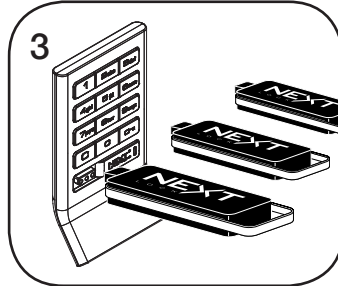

3
Insert each additional Manager Key one at a time.
A two-tone beep will be heard for each Manager Key registered.

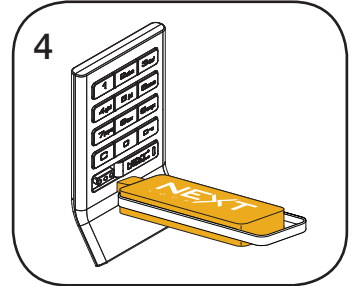

4
Insert the Programming Key.
A two-tone beep will be heard and the LED will turn off.
Repeat above steps for each lock or follow instructions to [Express Register Manager Keys](#) to register the same Manager Keys to multiple locks.

Replace Keys

Replacement keys must be purchased and registered to the locks to prevent the lost/stolen keys from operating a lock.

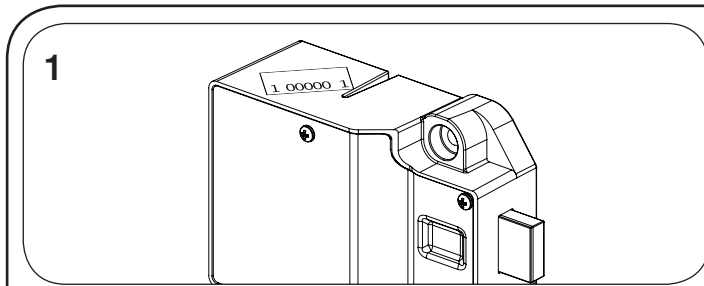

1
To replace the Programming Key:
Note the order number (found on the lock's rear unit).



2
Contact Digilock Support to purchase a replacement Programming Key.

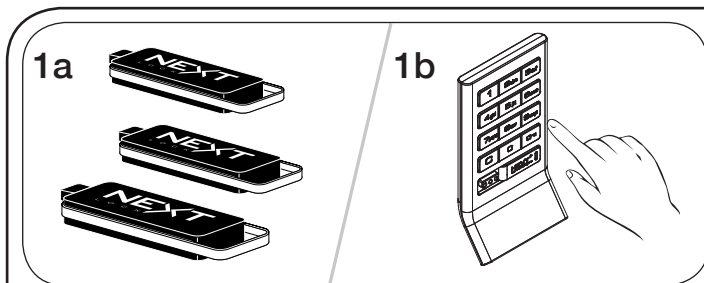

1a
To replace the Manager Keys:
Collect all remaining Manager Keys.
Go to any lock operated by the Manager Keys.
Press **[C]** **[0]** **[5]** **[5]** **[0]**.

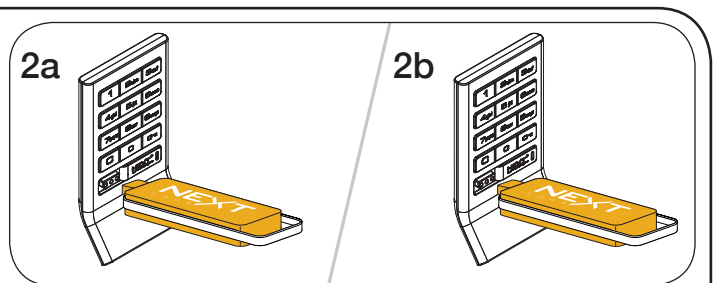

2a
Insert the Programming Key.
A two-tone beep will be heard and the LED will turn on.
Insert the Programming Key again.
Three sets of two-tone beeps will be heard and the LED will turn off. All previously registered Manager Keys are erased.
Follow instructions to [Add Manager Keys](#) to register the remaining Manager Keys to the locks.

Programming Instructions

Set Lock Functionality

Each lock can be set for either shared or assigned use functionality. Press **[C]** to check functionality. If in shared use, LED is red. If in assigned use, LED is green.

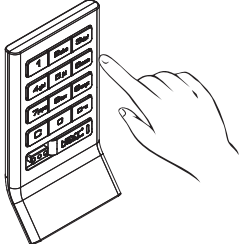
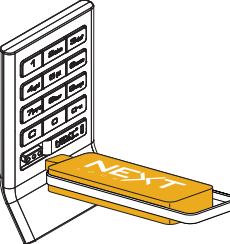
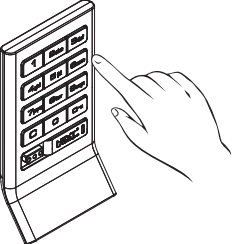
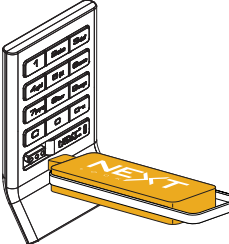
| | | | |
|---|---|---|---|
| <p>1</p>  | <p>2</p>  | <p>1</p>  | <p>2</p>  |
| <p>To set for assigned use: Press [C] [6] [5] [0]. The LED will turn on.</p> | | <p>To set for shared use: Press [C] [5] [6] [0]. The LED will turn on.</p> | |
| <p>Insert the Programming Key. A two-tone beep will be heard and the LED will turn off.</p> | | <p>Insert the Programming Key. A two-tone beep will be heard and the LED will turn off.</p> | |

Assign the User Credential (for assigned use functionality only)

Make sure that the lock is set for assigned use functionality. Once a user credential is assigned, the previously assigned user credential will no longer operate the lock.

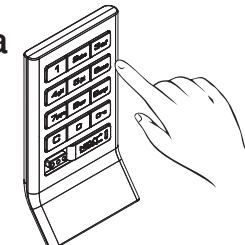
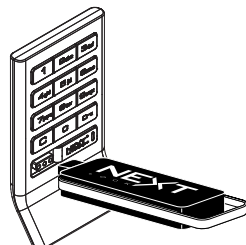
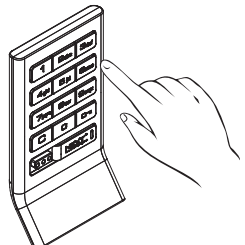
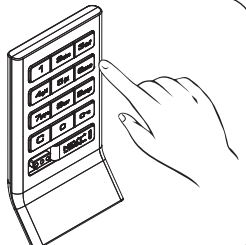
| | | | |
|---|--|--|--|
| <p>1a</p>  | <p>1b</p>  | <p>2a</p>  | <p>2b</p>  |
| <p>Assign a User Code: Default user code [1] [2] [3] [4] Press [C] [0] then insert a registered Manager Key. The LED will turn on.</p> | | <p>Press [C] [new 4-digit code] [0]. A two-tone beep will be heard. Press [C] [the same 4-digit code] [0]. Two sets of two-tone beeps will be heard and the LED will turn off.</p> | |

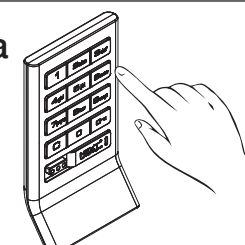
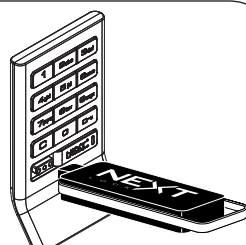
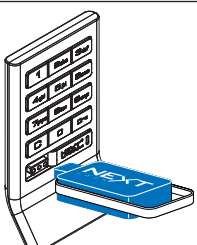
| | | |
|--|--|--|
| <p>1a</p>  | <p>1b</p>  | <p>2</p>  |
| <p>Assign a User Key: Press [C] [0] then insert a registered Manager Key. The LED will turn on.</p> | | <p>Insert a User Key. A two-tone beep will be heard and the LED will turn off.</p> |

Set Additional Lock Features (for shared use functionality only)

LED Usage Indicator

When in shared use functionality, each lock can be programmed to have the LED flash or not flash while the lock is in use. The default setting is ON (red LED flashes while lock is in use).

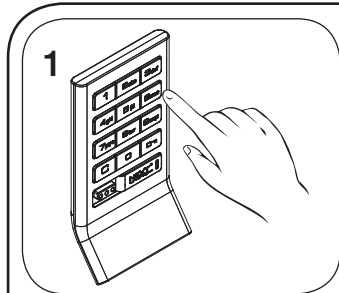

1

To turn off the LED Usage Indicator:

Press **[0] [0] [9] [2] [0]**.
The LED will flash.

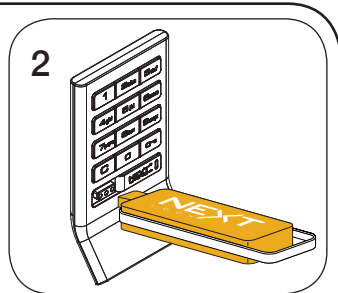

2

Insert the Programming Key.
A two-tone beep will be heard
and the LED will turn off.

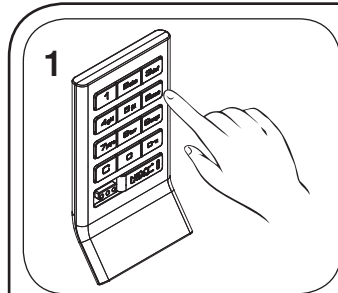

1

To turn on the LED Usage Indicator:

Press **[0] [0] [9] [1] [0]**.
The LED will flash.

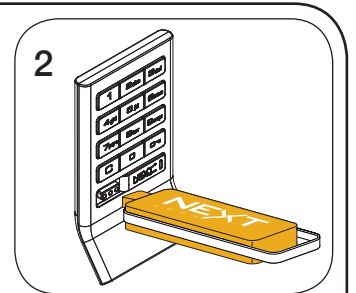

2

Insert the Programming Key.
A two-tone beep will be heard
and the LED will turn off.

Auto Unlock

When in shared use functionality, each lock can be programmed to auto unlock after a set number of hours. The default setting is OFF (does not auto unlock).

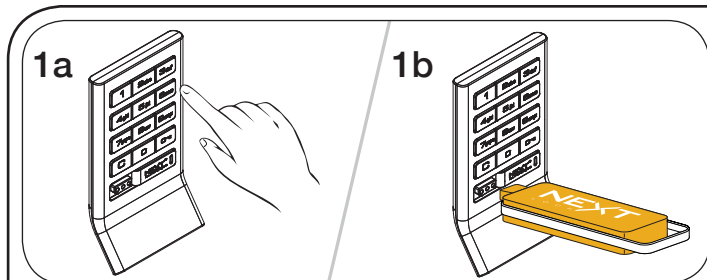

1a

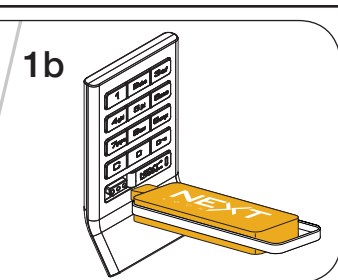

1b

To turn on Auto Unlock:

Press **[0] [0] [9] [5] [0]**.
The LED will flash.
Insert the Programming Key.
The LED will turn on.

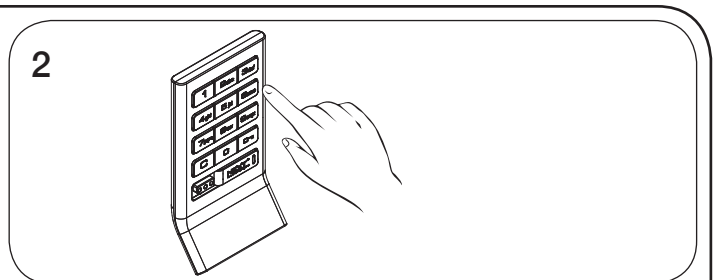

2

Press the set number of hours from **[1] - [9] [9]** then press **[0]**.
Two sets of two-tone beeps will be heard and the LED will turn off.
For example: Press **[8] [0]** to set the lock to auto unlock after 8 hours.

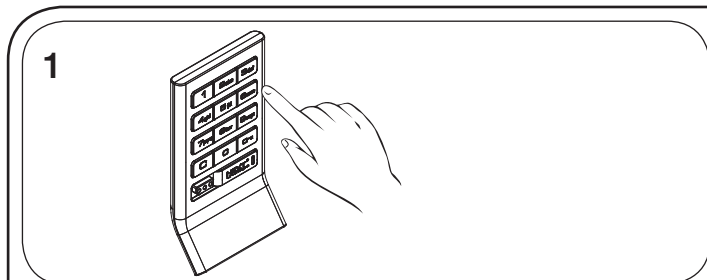

1

To turn off Auto Unlock:

Press **[0] [0] [9] [4] [0]**.
The LED will flash.

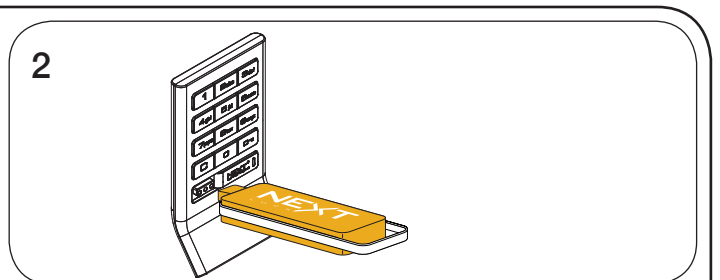

2

Insert the Programming Key.
A two-tone beep will be heard and the LED will turn off.

Operating Instructions - In Shared Use Functionality

In shared use functionality, users enter a self-selected 4-digit User Code or insert any User Key to lock and the same User Code or User Key to unlock. Once unlocked, the locker is available for a different user.

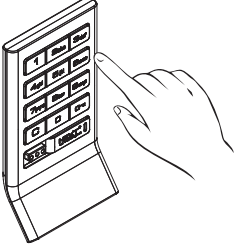

1a

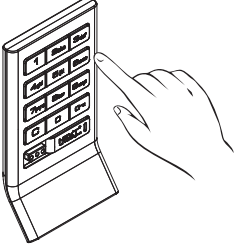

1b

Operate with a User Code
To lock: Press [] [any 4-digit code] [].
To unlock: Press [] [the same 4-digit code] [].*

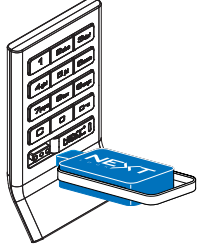

1a

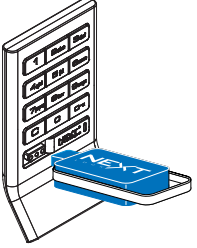

1b

Operate with a User Key
To lock: Insert any User Key.
To unlock: Insert the same User Key.

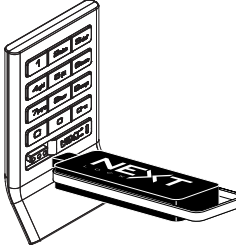

1a

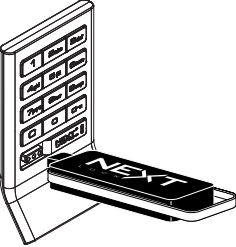

1b

Operate with a Manager Key
To unlock: Insert a registered Manager Key.
To relock: Insert a registered Manager Key.**



1a



1b

Operate with the Programming Key
To unlock: Press [] [] then insert the Programming Key.
To relock: Press [] [] then insert the Programming Key.**

*After 3 consecutive incorrect user code entries, the keypad will be disabled for 1 minute (Sleep Mode).

**If a registered Manager Key or the Programming Key is used to relock, the previous user credential will continue to operate the lock.

Operating Instructions - In Assigned Use Functionality

In assigned use functionality, users unlock their assigned locker with either their 4-digit User Code or User Key. To reassign a locker to a different user, follow instructions to [Assign the User Credential](#).

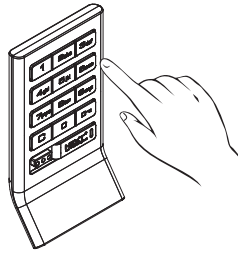

1a

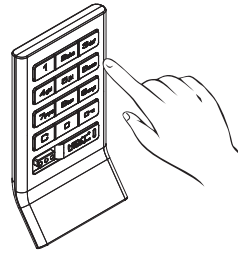

1b

Operate with the User Code
To unlock: Press [1] [assigned 4-digit code] [4].*
To relock: Press [1] [4] [4].

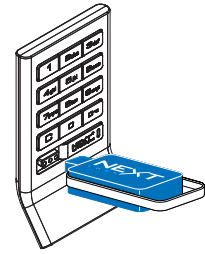

1a

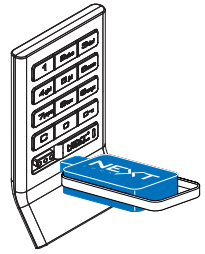

1b

Operate with the User Key
To unlock: Insert the assigned User Key.
To relock: Insert the assigned User Key.

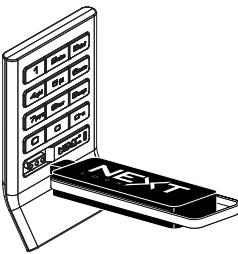

1a

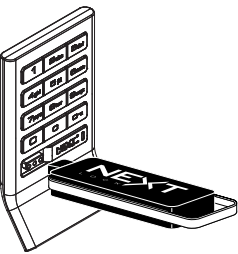

1b

Operate with a Manager Key
To unlock: Insert a registered Manager Key.
To relock: Insert a registered Manager Key.



1a



1b

Operate with the Programming Key
To unlock: Press [1] [4] then insert the Programming Key.
To relock: Press [1] [4] then insert the Programming Key.

*After 3 consecutive incorrect user code entries, the keypad will be disabled for 1 minute (Sleep Mode).

Support

Sleep Mode

After three consecutive incorrect User Code entries to unlock, the lock will go into “Sleep Mode” for one minute and for an additional minute for each subsequent incorrect entry. The keypad is disabled while in “Sleep Mode”. A registered Manager Key may be used to unlock while the lock is in “Sleep Mode”.

Error Condition Indicators

10 rapid beeps:

The lock is binding which means that either door alignment or items in the locker are preventing the lock from operating. Press on the door while operating the lock. If error condition persists, contact Digilock support for assistance.

2 sets of three beeps:

The batteries are low. Replace the batteries.

Does not Unlock with the User Code or User Key

The lock does not recognize the User Code or User Key. For immediate access, operate with a registered Manager Key. If in assigned use functionality, follow instructions to [Assign the User Credential](#) to assign a new User Code or User Key to the lock.

Does not Operate with a Manager Key

The lock does not recognize the Manager Key. Follow instructions to [Add Manager Keys](#) to register the Manager Key to the lock. For immediate access, operate with another registered Manager Key or with the Programming Key.

Does not Operate with the Programming Key

The lock does not recognize the Programming Key. If the Programming Key has been replaced, operate with the Replacement Programming Key. Contact Digilock support for additional assistance.

No Audible Feedback when **C** is Pressed

- The lock may be in “Sleep Mode” or the batteries may need to be replaced. For immediate access, operate with a registered Manager Key.
- The front unit may not be properly connected to the rear unit. Remove the lock from the door and check the connection.

Battery Replacement (shown with cable rear unit)

It is not necessary to uninstall the lock from the door.

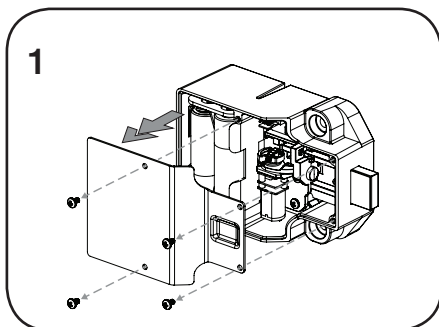

1 Remove the screws and the cover plate.

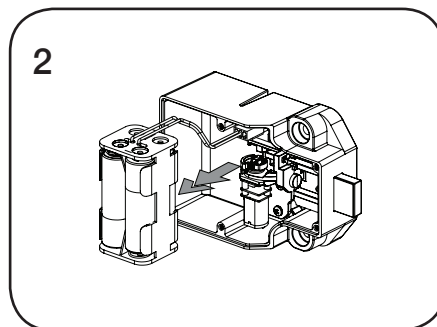

2 Pull the battery pack from the rear housing. Replace with four premium alkaline AA batteries.

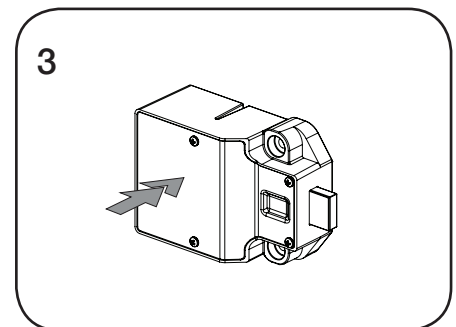

3 Place the battery pack back into the rear housing and screw cover plate in place.